

# USER GUIDE

DIRECTV® HD RECEIVERS





When you see the ENERGY STAR label on your set-top box, it means that your set-top box is ENERGY STAR qualified, giving you the benefit of saving energy and helping our environment.

However, ENERGY STAR labeled HD DVR set-top boxes qualify for ENERGY STAR **only when configured with the DIRECTV Whole-Home DVR service**. All other ENERGY STAR labeled set-top boxes, when used in conjunction with a DIRECTV subscription, meet ENERGY STAR criteria without requiring the consumer to take any additional steps.

# WELCOME TO THE DIRECTV FAMILY!

Welcome! Now that you're plugged in, it's time to start enjoying access to over 285 channels of TV programming, satellite music and a great selection of the biggest box office movies from DIRECTV CINEMA™. We'll take you step by step through everything from pushing the POWER button to searching for and finding your favorite programs. This user guide applies to the DIRECTV® HD Receiver. Because this user guide was designed to accommodate several models, your receiver and its user interface may vary slightly from what is shown here.

## Getting Connected

If a professional installed your DIRECTV® HD Receiver, you're ready to start watching TV. If your receiver was not professionally installed or you just added a surround sound system or other equipment, please see Appendix 1, "Setup & Activation."

### IMPORTANT:

- You must subscribe to HD Access to view the HD channels included in your programming package.
- DIRECTV hardware, programming and HD Access fee available separately. For information and pricing regarding programming and HD Access, please visit [directv.com](http://directv.com).

# TABLE OF CONTENTS

Welcome to the DIRECTV Family! .....	3
Safety & Care .....	6
Product Information .....	8

## CHAPTER 1: USING YOUR REMOTE CONTROL

---

Your Remote Control .....	10
---------------------------	----

## CHAPTER 2 - CHANNELS & PROGRAM INFO

---

Program Guide .....	14
Channel Banner & TV Options .....	20
The DIRECTV Menu .....	23

## CHAPTER 3: EXTRAS & SPECIAL FEATURES

---

Extras .....	26
Messages .....	26
Manage Autotunes .....	26
DIRECTV Active Channel .....	28
GSN Game Lounge .....	29

Caller ID .....	29
Music & Photos .....	30

## Special Features .....

GameSearch™ .....	32
Quicktue .....	32
ScoreGuide™ .....	33
TV Apps .....	33

## DIRECTV® Whole-Home DVR Service .....

## CHAPTER 4 - SETTINGS & HELP

---

Settings .....	40
Parental Controls .....	47
Favorite Channels .....	52
Help .....	53

## CHAPTER 5 - TROUBLESHOOTING & FAQs

---

Troubleshooting Tips .....	56
Frequently Asked Questions .....	59

## CHAPTER 6: WARRANTY AND OTHER INFO

---

Limited 90-Day Warranty .....	70
DIRECTV PROTECTION PLAN .....	73
FCC Customer Information .....	74
TERMS AND CONDITIONS FOR USE OF SOFTWARE ("TERMS") .....	77

## APPENDICES

---

Appendix 1: Setup and Activation .....	88
Appendix 2: Connections to TV and Equipment .....	89
Appendix 3: Receivers Front and Back Panels .....	95
Appendix 4: How to Network Your HD Receiver .....	99
Appendix 5: About High-Definition .....	106
Index .....	110
Icon Reference .....	114

# SAFETY & CARE

Your DIRECTV® Receiver has been designed and manufactured to stringent quality and safety standards. You should, however, be aware of the following important precautions for safe and optimal use of the equipment. Meaning of symbols printed on the rear panel of the product:



This symbol indicates that dangerous voltage with a risk of electric shock is present within this unit.



This symbol indicates that there are important operating and maintenance instructions in the literature accompanying this unit.

## Important Safety Instructions

1. Read these instructions.
2. Keep these instructions.
3. Heed all warnings.
4. Follow all instructions.
5. Do not use this apparatus near water.
6. Clean only with dry cloth.
7. Do not block any ventilation openings. Install in accordance with the manufacturer's instructions.
8. Do not install near any heat sources such as radiators, heat registers, stoves, or other apparatus (including amplifiers) that produce heat.
9. Do not defeat the safety purpose of the polarized or grounding-type plug. A polarized plug has two blades with one wider than the other. A grounding type plug has two blades and a third grounding prong. The wide blade or the third prong are provided for your safety. If the provided plug does not fit into your outlet, consult an electrician for replacement of the obsolete outlet.
10. Protect the power cord from being walked on or pinched particularly at plugs, convenience receptacles and the point where they exit the apparatus.
11. Use only attachments/accessories specified by the manufacturer.
12. Use only with the cart, stand, tripod, bracket or table specified by the manufacturer, or sold with the apparatus. When a cart is used, use caution when moving the cart/apparatus combination to avoid injury from tip-over.
13. Unplug this apparatus during lightning storms or when unused for long periods of time.
14. Refer all servicing to qualified service personnel. Servicing is required when the apparatus has been damaged in any way, such as power-supply cord or plug is damaged, liquid has been spilled or objects have fallen into the apparatus, the apparatus has been exposed to rain or moisture, does not operate normally, or has been dropped.



**WARNING:** To reduce the risk of fire or electric shock, do not expose this product to rain or moisture. The apparatus shall not be exposed to dripping or splashing and no objects filled with liquids, such as vases, shall be placed on the apparatus.



**CAUTION:** To reduce the risk of electric shock, do not remove cover (or back).  
No user-serviceable parts inside.  
Refer servicing to qualified service personnel.

**IMPORTANT:** Be sure not to place your DIRECTV® Receiver near anything WET or HOT!  
If this product is rated at 240VAC, a suitable attachment plug should be used.

**CAUTION:** Avoid moisture to reduce the risk of fire or electric shock. The DIRECTV® Receiver should not be used near water (for example, kitchen sink, bathtub, pool, damp basement). Also, never spill liquid on the receiver. Do not place vases or other vessels containing liquid on top of it.

**TIP:** We highly recommend plugging the DIRECTV® Receiver into a surge protector to prevent damage from fluctuations in your power supply.

- Ensure proper ventilation — the vent slots on the DIRECTV® Receiver must be left uncovered to allow proper airflow to the unit. Blocking the airflow to the unit could impair performance or damage your receiver and other components.
  - Do not stack electronic components or other objects on top of the DIRECTV® Receiver. Also, do not stack the receiver on top of a "hot component" such as an audio power amplifier.
  - Protect your components from power surges by connecting all the components before plugging any power cords into the wall outlet. Use of a surge protector is also recommended.
  - Don't overload power outlets or extension cords, which can result in the risk of fire or shock. It's also important to use only the type of power source indicated on the marking label or in this manual.
  - Avoid audio hum or interference by inserting all cable plugs firmly into their jacks. Also, place Audio/Video [A/V] cables to the sides of the TV back panel rather than down the middle once connected. Try not to coil any twin-lead cables and keep them away from A/V cables as much as possible.
  - Never insert objects of any kind into any openings in the DIRECTV® Receiver (other than the DIRECTV® Access Card as detailed in this manual).
  - Place it on a flat, hard surface — do not operate the DIRECTV® Receiver on a carpet or other padded surface.
  - Always unplug your DIRECTV® Receiver before moving it.
  - Always unplug the DIRECTV® Receiver, TV and other equipment before you connect or disconnect any cables.
  - The only way to disconnect the DIRECTV® Receiver from the power supply is to remove the power cord. The DIRECTV® Receiver unit must therefore be installed next to the power point which must be easily accessible.
  - **CAUTION:** Electric Shock — never attempt to disassemble the DIRECTV® Receiver yourself; always take it to a qualified service person when repair is required. Opening or removing covers may expose dangerous voltage or other risks. Incorrect reassembly can cause shock when receiver is subsequently used. Attempted self-repair may also void your warranty. Changes or modifications not expressly approved by the party responsible for compliance (by the warranty or by the manufacturer) could void the user's authority to operate the equipment.
  - Do not drop your DIRECTV® Receiver and always move it with care.
  - Have your DIRECTV® Receiver professionally serviced (do not attempt to service it yourself).
  - Any changes or modifications in construction of this device which are not expressly approved by the party responsible for compliance could void the user's authority to operate the equipment.
  - If you move your DIRECTV® Receiver between locations at different temperatures, allow it to reach room temperature before you apply power to it.
  - Do not pick up or otherwise move your DIRECTV® Receiver while it is connected to the AC power supply. If you want to move your set-top box, first disconnect it, then wait at least 30 seconds before continuing.
  - **CAUTION:** To reduce the risk of fire, use only No. 26 AWG or better telecommunications line cord.
  - **CAUTION:** Replace remote control batteries with same or equivalent type. There is danger of explosion if batteries are incorrectly replaced.
  - For your information: The identification sticker can be located behind the small door on the front panel of your receiver.
  - The telecommunication network voltage used is the category number 3.
- Note to Satellite Dish Installer:** This reminder is provided to call your attention to articles 810 and 820 of the 2005 National Electrical Code. Refer to article 810, in particular 810-1 and 810-15, for required grounding of the metal structure of the dish antenna. Refer also to the 810-2 which, by reference to article 820, requires that the satellite dish coaxial cable shield be connected to the grounding system of the building as close to the point of cable entry as practical.

## PRODUCT INFORMATION

Keep your receipt to obtain warranty parts and service and for proof of acquisition. Attach it here and record the serial and model numbers in case you need them. \*These numbers are typically located behind the card door on the front panel of your receiver.

Model No. *	
Serial No.	
Acquisition Date	
Dealer/Address/Phone	
Access Card *	
Receiver ID *	



# CHAPTER 1: USING YOUR REMOTE CONTROL

---

<b>Your Remote Control .....</b>	<b>10</b>
Turning Your Equipment On and Off .....	10
Navigation and Destination Buttons .....	11
Shortcut Buttons .....	11

# YOUR REMOTE CONTROL

## TURNING YOUR EQUIPMENT ON AND OFF



Mode Switch



**NOTE:** Each time you press a button, a green light at the top of the remote flashes. If the light flashes several times for just one press, it means the batteries (size AA) are getting low and need to be replaced.

**These two buttons turn your TV and DIRECTV® Receiver on or off together.** If your DIRECTV® System was installed professionally, your remote has already been programmed to operate your TV. If you need to reprogram the remote for a new TV or for any other reason, press MENU, select "Settings & Help", "Settings", then "Remote Control". Follow the step by step instructions.

Use the POWER (PWR) button and Mode Switch to turn a single component on or off (for example a DVD player or surround sound system). Simply slide the mode switch to the position that matches the component you want to control and then use the POWER button to turn it off or on. **The mode switch must always be in the left-most position to control your DIRECTV® Receiver.** If the mode switch is in a position that has not been programmed, or if you press a button that is not supported by that particular piece of equipment, an onscreen message will pop up to alert you.

## NAVIGATION AND DESTINATION BUTTONS



The buttons in the middle of the remote are navigation and destination keys. Press the GUIDE button to go to the program guide screen. Press the ACTIVE button to go to the DIRECTV Interactive™ services channel. The LIST button takes you to the To Do List. Press EXIT to get out of any menu screen and return to live TV. Use the ARROW buttons and SELECT button to navigate through the guide or any menu screen. Press BACK to move back to the previous screen. The MENU key takes you to the main menu where you go to access all of the features available in your system. Press INFO on any show to see information about that show.

## SHORTCUT BUTTONS



You can move through all of the DIRECTV user screens using only the direction ARROW buttons and the SELECT button as appropriate. However, the RED, GREEN, YELLOW, and BLUE buttons on the remote are special short cuts that change function depending on which menu screen you are looking at. As you use the system, look in the bottom left of particular screens for hints that tell you which color button to use for a particular short cut. You'll see several examples in this chapter.

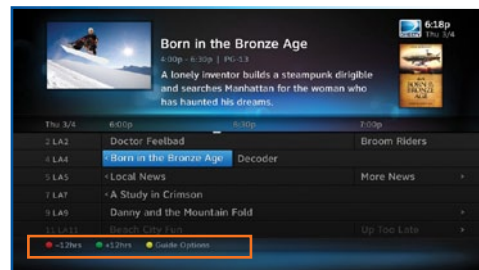



## CHAPTER 2 - CHANNELS & PROGRAM INFO

---

<b>Program Guide</b> .....	<b>14</b>
Program Info .....	14
Local Channels .....	14
HD and SD Channels .....	15
Unsubscribed Channels .....	15
3D Channels .....	15
DIRECTV CINEMA™ .....	16
Pay Per View Events .....	16
Interactive Channels .....	17
Mini Guide .....	18
Filtering the Guide .....	18
Guide Options .....	19
<b>Channel Banner &amp; TV Options</b> .....	<b>20</b>
Messages .....	20
Info .....	20
Last 4 .....	21
Favorite Channels .....	21
Closed Captioning .....	21
Audio/Video Options .....	22
Parental Controls .....	22
Search .....	23
<b>The DIRECTV MENU</b> .....	<b>23</b>
Recordings .....	24
Extras .....	24
Settings & Help .....	24

## PROGRAM GUIDE

To see what's showing, press the **GUIDE** button to display the onscreen program guide. The guide holds 7 days of programming for HD receivers. You can navigate in the guide as follows: use the **ARROW** buttons to move one cell at a time up/down/left/right; use the **CHAN/PAGE** button to scroll a whole page up or down; type in the channel number to go directly there. Look for the color-button hints at the bottom of the screen for shortcuts (use the **GREEN** button to move ahead in time 12 hours, once there use the **RED** button to come back 12 hours).

### PROGRAM INFO

Press **INFO** on any program to see its associated program info screen. The Info screen displays the description for a program. Additionally, it allows you to watch or record the program, view a list of other showings or episodes, and more. Rotten, Tomatoes™ fresh tomato and rotten tomato icons represent critics' scores. Flixster uses upright popcorn and spilled, popcorn icons to represent audience scores. A rating of better, than 60% awards either the fresh tomato or upright popcorn.

### LOCAL CHANNELS

Your DIRECTV-provided local channels can be found in the guide from channel numbers 2 through 69.

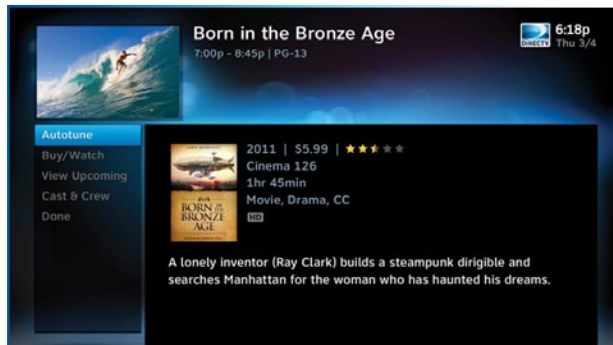

## HD AND SD CHANNELS

DIRECTV has a tremendous offering of HD channels and they are spread throughout the guide. To find them, look for HD after the program title in the guide. If you want to see only the HD version of a channel in the guide go to Chapter 4, "Settings & Help:Settings:Display" for instructions.

## UNSUBSCRIBED CHANNELS

Channels in the guide that are not part of your subscription package are shown grayed out. You can customize your guide to hide those channels. See Chapter 4, "Settings & Help:Favorite Channels" for details.

## 3D CHANNELS

Just like the 3D experience in movie theatres, DIRECTV 3D makes you feel like you could reach out and touch whatever you're watching. Just hook up your 3D HDTV, put on your 3D glasses and watch the best in entertainment virtually jump into your home. 3D channels are in the 100s series in the Guide, starting on channel 103. For a list of 3D programs, press GUIDE, press the YELLOW button and then select "Sort programs by category". Select "3D" and a list of 3D programs will display. Note that if you do not have 3D-capable hardware, you will not be able to tune to 3D channels.

HD  
Channel  
Unsubscribed  
Channel

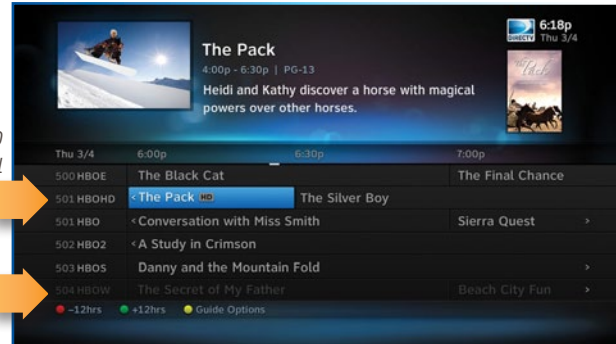

**NOTE:** There is no separate 3D fee, but DIRECTV 3D programming is broadcast in HD and requires HD Access, HD receiver (HR21, H21 or later), compatible 3D HDTV and 3D glasses. CHOICE™ package or higher required for ESPN 3D. For more information, visit [directv.com/3D](http://directv.com/3D).

## PROGRAM GUIDE

### DIRECTV CINEMA™

You don't have to go out for the biggest box office movies! The latest hits are available 24 hours a day. Find them in the program guide starting at channel 125.

To order a movie from the program guide, highlight the title and press INFO on your remote. Select the Buy option and follow the onscreen instructions. As long as your receiver is connected to a land-based phone line or the Internet, you can use your remote to order. Otherwise, order at [directv.com](http://directv.com). If you order a movie in advance, you may cancel it for any reason before the program starts airing. To cancel a purchase, press MENU, then select "Extras," then "Manage Autotunes," then "Purchases." Select the program, then select "Cancel PPV" to delete it.

### PAY PER VIEW EVENTS

Special events like UFC, Boxing, WWE and more are listed in the program guide starting around channel 120.

Ordering PPV events works the same way as ordering DIRECTV CINEMA movies from the program guide. See above for details.

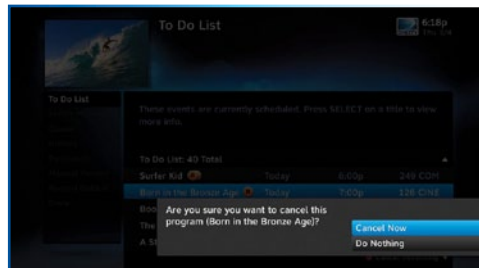
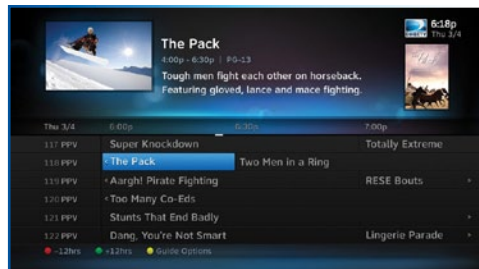



## INTERACTIVE CHANNELS

Interactive channels are unique. In addition to video and audio, they also contain a software application that lets you interact with what you see onscreen. When accessing these channels, you will have to wait a few seconds for the software to download.

- Press the ACTIVE button on your remote to get the latest weather, horoscopes, lottery results and more. The channel is ready to interact when the yellow highlight box appears.
- To exit an interactive channel, type in a new channel number or press GUIDE and pick the channel you want to move to.
- Other interactive channels such as, News Mix and Sports Mix let customers with a qualifying programming package see up to eight of the hottest channels on one screen. Move the yellow highlight box around using the direction arrows on your remote to hear the audio associated with each channel. If you want to see one of the channels full-screen, move the yellow highlight box over it and press SELECT.



# PROGRAM GUIDE

## MINI GUIDE

If you are watching a show and want a quick look at what's on next, press the BLUE button to display a one-line mini program guide. You can use it for the current channel or you can type in a new channel number to see what's on there. Look for the channel or time you want using the UP, DOWN, LEFT and RIGHT arrows. Press SELECT on the new show if you want to go to that channel.

One-line  
mini-guide

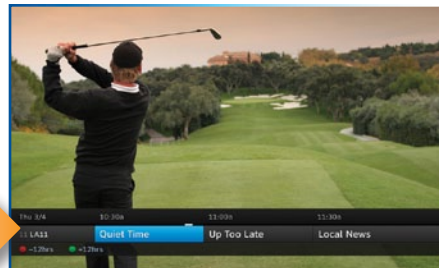

## FILTERING THE GUIDE

There may be times when you want to temporarily trim down the channels that are shown in the guide, filtering them according to the type of program you are looking for. For example, you may want to see just sports, movies or news. In this case, press GUIDE twice to display the guide filter.

Use the arrow keys to highlight the category you want and press SELECT. The guide will now show only the channels that match that category. Look for the label in the bottom right of the guide to see how it is being filtered.

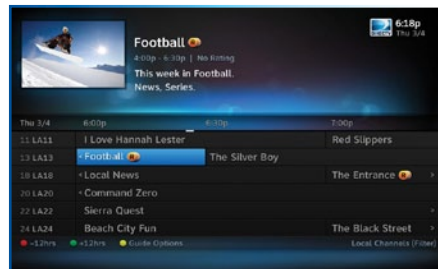
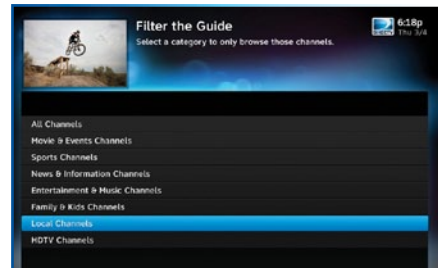

Look to the  
right to  
see how the  
guide is being  
filtered.

## GUIDE OPTIONS

From the program guide, press the YELLOW button to display “Guide Options.”

### Sort Programs by Category:

Select “Sort programs by category”, then select a category to see a list of shows in chronological order that match your sort criterion.

### Jump to a Date & Time:

Select “Jump to a date & time” to quickly go to a future date and time in the guide.

### Change Favorites List:

By default, your program guide displays all channels offered by DIRECTV, some of which may not be in your programming package. “Change favorites list” allows you to toggle the channels displayed in your guide among the following: “All Channels,” “Channels I Get” (channels you subscribe to) or a custom list of channels you have defined. The “Edit Settings” option allows you to modify the channels in your custom list. See Chapter 4, “Settings & Help:Favorite Channels” for details.

### Pay Per View:

Select “Pay Per View” then select a program type. The receiver will search for featured movies, sports or events that are available for “rent” on DIRECTV.

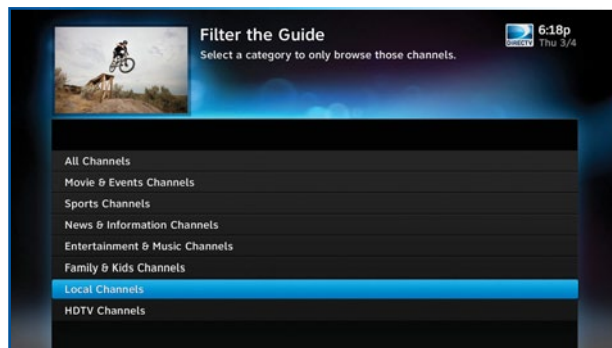
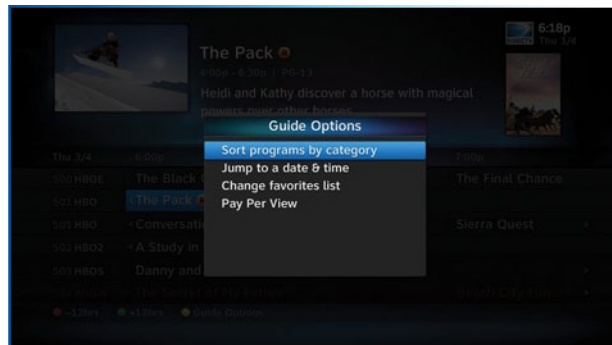

## CHANNEL BANNER & TV OPTIONS

When you find a current show in the guide you want to watch, press SELECT and the receiver changes to that channel. The channel banner briefly displays at the top of the screen with program title, channel number, date, time and other information. You can also press INFO to display the channel banner while watching a program. Select "Info" then "More Info" for detailed program information and other options.

The channel banner also provides easy access to Messages, the last four channels you watched, Favorite Channels, Closed Captioning, Audio/Video options, and Parental Controls. Use the ARROW keys to highlight an option, then press SELECT.

### MESSAGES

Select "Messages" to see your messages. DIRECTV sends messages to you for important news items or special promotions. When you have new messages, an "envelope" icon appears in the channel banner.

### INFO

Select "Info" to read a brief description of the program. For detailed program information and other options select "More Info".

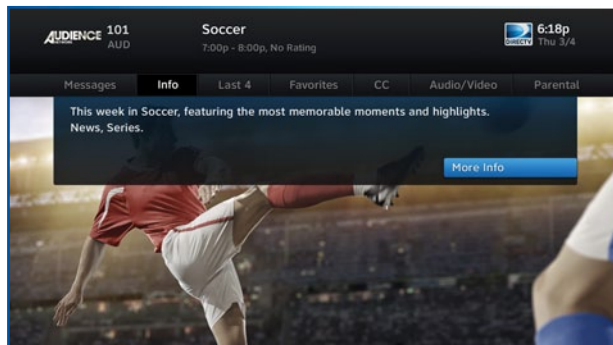
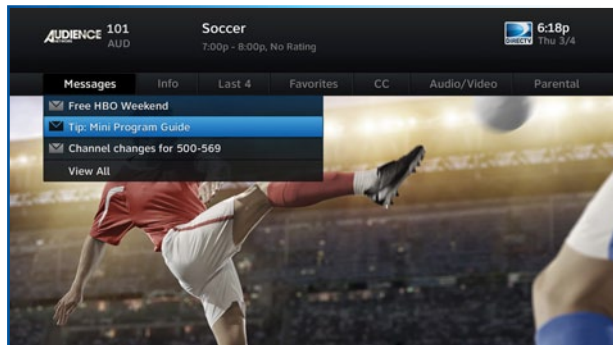

## LAST 4

Select “Last 4” to see a list of previous channels you’ve watched (up to 4). When you select a channel from this list, the receiver will tune to that channel. This is an easy way to toggle among the channels you watch most often.

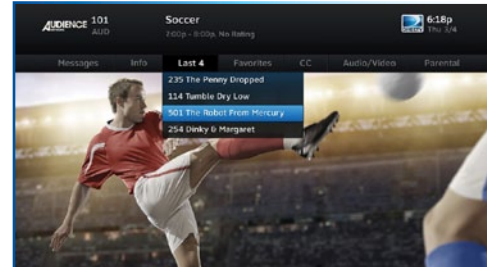

## FAVORITE CHANNELS

Select “Favorites” to update the program guide to show only the channels you want to see. You have 4 options to choose from: “All Channels”, “Channels I Get”, “Custom 1” and “Custom 2”. Channels I Get displays only the channels you subscribe to. Custom 1 and 2 are self-created lists of your favorite channels. If one of your self-created lists is active, select the “Add...” or “Remove...” option to add or remove the current channel from that list.

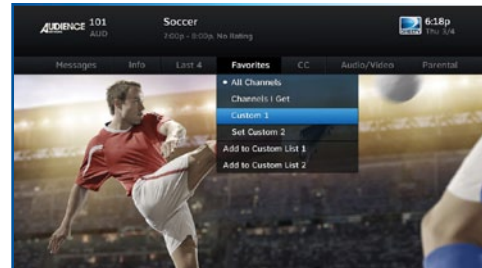

## CLOSED CAPTIONING

Select the “CC” option, then select either “DIRECTV Subtitles” or “Closed Captioning” for the option you want. Both options display the same text so only one may be “ON” at a time. The display format is the only difference so check out both to determine your preference. (Select OFF to turn the display of subtitles or closed captioning off.)

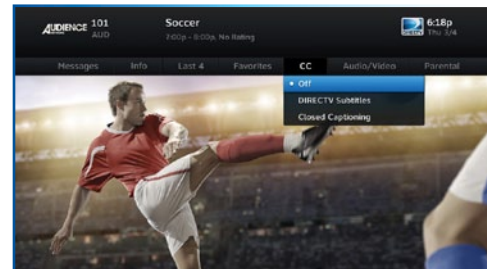

# CHANNEL BANNER & TV OPTIONS

## AUDIO/VIDEO OPTIONS

Select "Audio/Video" to change the resolution and format of your display and to change audio to an alternate language, when available. Select "Change Resolution & Format" to change the display settings; each press of SELECT toggles to the next available option. The current settings are shown in gray text.

You may also select a language from options listed. Not all programs have alternate languages.

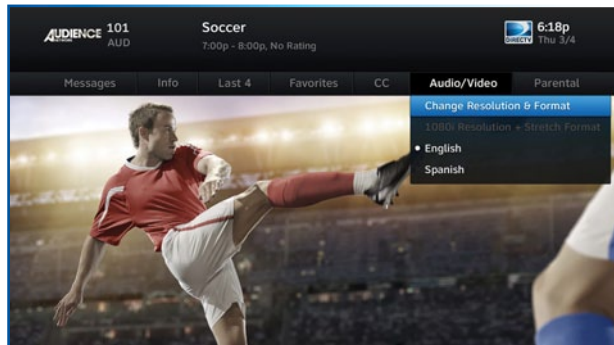

## PARENTAL CONTROLS

Select "Parental" to quickly lock or unlock your receiver. You can also customize your parental controls settings by selecting "Parental Controls". For more information on parental controls settings, see the "Parental Controls" section in Chapter 4.

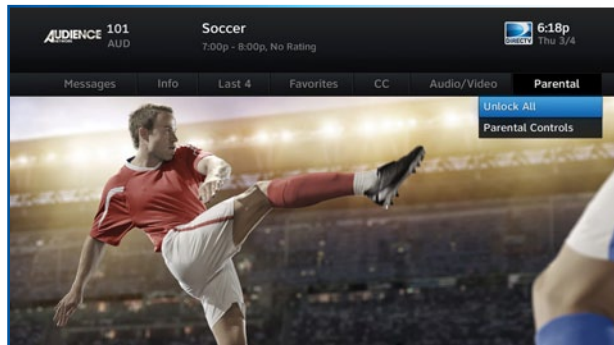

The DIRECTV Menu lets you access Search, Extras, and Settings & Help. Press MENU on your remote to see your available options.

## SEARCH

To search for programs, press MENU on your remote, select “Search” and then select either: Titles, People, Channels, Keywords or Recent Searches.

Enter your search term using the onscreen keypad, or use the numbers on your remote to “triple tap” the words. There’s no need to enter leading articles such as, “the” or “an”. Whether you’re looking for a movie, show, person, channel, sports, etc., as soon as you start typing, we’ll instantly give you results. Search finds all matching programs within the 7-day program guide.

Select “Keywords” to find all shows with a specific word in its title or description. For example, if you use your favorite sports team as your keyword, the results will include available games, interviews, documentaries, etc. Type in your keyword on the search screen and select “Continue”. You’ll be given the option to select a category to narrow your results. Select individual programs or select “Autotune” to automatically tune to all programs matching your keyword search.

You can repeat a previous search without re-typing your search term. Select “Recent Searches” and then select a previous search from the list.

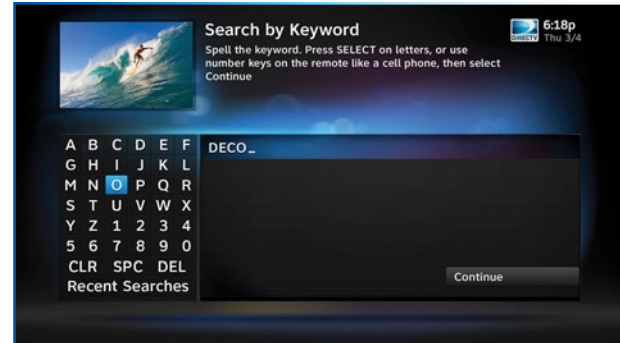
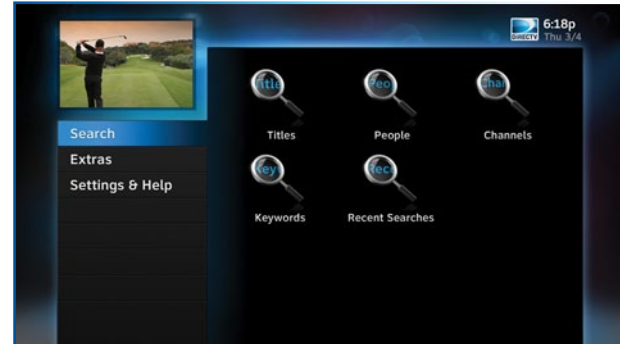

# THE DIRECTV MENU

## RECORDINGS

The “Recordings” option only displays if you subscribe to DIRECTV’s Whole-Home DVR service and your HD Receiver is connected to your home network. Learn more in Chapter 3, “Extras & Special Features:DIRECTV Whole-Home DVR Service.”

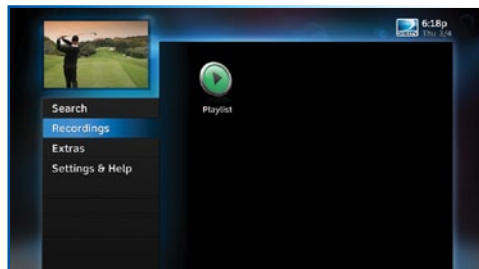

## EXTRAS

Use the “Extras” option to access features such as, Messages, Manage Autotunes, the DIRECTV Active channel, GSN Game Lounge, TV Apps and Caller ID. See Chapter 3, “Extras & Special Features” for a detailed description of each feature.



## SETTINGS & HELP

The Settings & Help option lets you access Settings, Parental Controls, Favorite Channels and Help. For detailed information on these topics, see Chapter 4, “Settings & Help.”





## CHAPTER 3: EXTRAS & SPECIAL FEATURES

---

<b>Extras</b> .....	<b>26</b>
Messages .....	26
Manage Autotunes .....	26
DIRECTV Active Channel .....	28
GSN Game Lounge .....	29
Caller ID .....	29
Music & Photos .....	30
<b>Special Features</b> .....	<b>32</b>
GameSearch™ .....	32
Quicktue .....	32
ScoreGuide™ .....	33
TV Apps .....	33
<b>DIRECTV® Whole-Home DVR Service</b> .....	<b>34</b>

## EXTRAS

Press MENU on your remote and select “Extras” to access these great features:

### MESSAGES

Press MENU, select “Extras” and then “Messages” to see your messages from DIRECTV. DIRECTV sends you messages about important news items or special promotions. We also notify you of software changes and new features that we download to your receiver.

### MANAGE AUTOTUNES

You can select future programs in the Guide to “autotune,” or automatically tune to the program when it airs. This way, you can be sure never to miss a favorite program, or you can use autotune to record a program using a connected video recorder.

From the Guide or Mini Guide, press the ENTER key on a highlighted program to schedule it to autotune with default options.

- Pressing ENTER once schedules the highlighted program to autotune. An autotune icon is displayed next to the program title to let you know it is scheduled.
- Pressing ENTER again cancels the autotune.

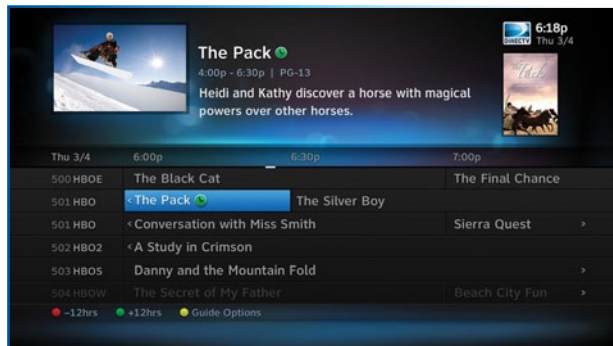
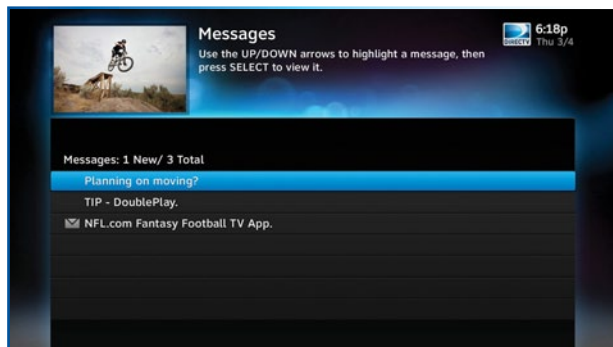

Once you've set up autotunes, you can view the status and history of those autotunes. Press MENU, select "Extras," and then "Manage Autotunes" to access the following options:

## To Do List

"To Do List" contains all of the autotunes your receiver is set to make in the future. The icons next to the titles indicate whether the autotune is a single event, or part of a series, or an autotune based on a person or keyword search. The list is ordered by time with the next autotune at the top and the furthest in the future at the bottom. You can use this screen to make sure your autotunes are properly scheduled or to cancel scheduled autotunes. Canceling autotunes is easy. Simply highlight the show you want to cancel and press the RED button on the remote.

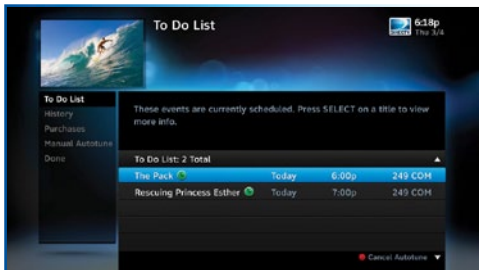

## History

Provides status information for every autotune scheduled, whether they were tuned, canceled or deleted. If you think something should have been autotuned, but wasn't, check here to look for an explanation.



## Purchases

Provides status information for all movies and Pay Per View events that were bought and, if viewed, the date and time.

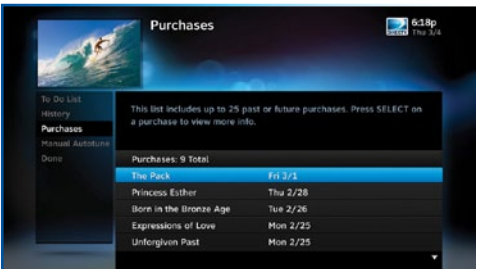

## EXTRAS

### Manual Autotunes

There may be times when you want to set up a manual autotune based on channel, time and date. In this case, select “Manual Autotune” and enter all of the options as you wish, including whether you want this to be a one-time or recurring autotune (for example, every Tuesday), channel, day and date, start time and duration. You can schedule a manual autotune up to 12 days in advance.

### DIRECTV ACTIVE CHANNEL

Press MENU, select “Extras”, then “Active” to access the DIRECTV Active™ Channel or simply press the ACTIVE key on your remote.

The DIRECTV Active™ Channel provides a variety of interactive services, including daily and extended weather forecasts, daily horoscopes, lottery results, the GSN Game Lounge, and a quick list of the most popular shows on DIRECTV at any given time.

For local weather on demand, press ACTIVE and select the “Weather” option. The first time you use this feature, you will have to enter your local ZIP code. You can view up to five cities by selecting the “My Cities” menu item and following the onscreen instructions.

To exit the DIRECTV Active channel, just enter a channel number or press the CHAN UP/DOWN key.”

Because it is an interactive channel, the DIRECTV Active screen may take a few moments to load. Please be patient.



## GSN GAME LOUNGE

Press MENU, select “Extras”, then “Game Lounge”. The GSN Game Lounge service contains memory and skill games that you can play onscreen using only your remote. There are free as well as subscription-only games to play. If you become a top scoring player, you will see your name on the leader board.

## CALLER ID

The Caller ID feature displays the number for incoming phone calls on your TV, and lets you view a list of phone calls you’ve received.

**NOTE:** You must subscribe to caller ID service through your phone company and your receiver must be connected to a phone line.

To set up your receiver to display Caller ID, press MENU, select “Extras”, then “Caller ID” then “Notification”. When the Notification option is on, you’ll see a notice on your TV screen whenever a call comes in.

You can review your 25 most recent calls in the call log at any time. To see your call log, press MENU, select “Extras”, then “Caller ID” and then select “Call Log.”

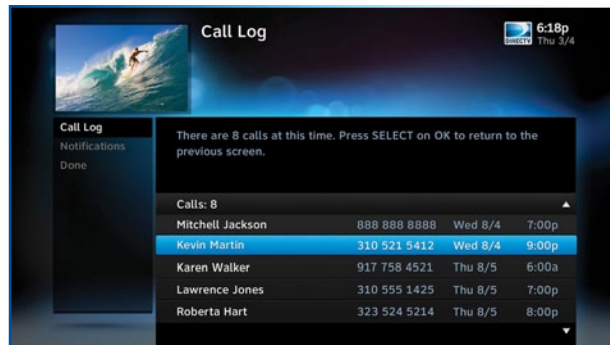

## EXTRAS

## MUSIC &amp; PHOTOS

"Music & Photos" is an optional item in the "Extras" menu, only shown when your HD Receiver is connected to your home network. Compatible models include DIRECTV HD Receiver (models H21 or later), DIRECTV HD DVR (models HR34 and HR20 or later) or DIRECTV Plus® DVR (model R22). Other models may support DIRECTV™ Media Share in the future.

Your DIRECTV Receiver can be connected to your home network to show photos and play music and videos that you have saved on your personal computer. You must have at least one personal computer running a media server (e.g. TVersity, Windows Media Player, Intel Viiv) in your network for this service to work. For help on setting up "Music & Photos" visit [directv.com/mediashare](http://directv.com/mediashare).

Once your HD Receiver is properly connected to the media server on your home network, press MENU, select "Extras" and select "Music & Photos." The DIRECTV Media Share screen will display.

- Select "Music" to access music by Artist, Album, Song, Playlists and Channel. Your favorite music will play as you watch TV or view photos from your PC. Once the desired songs are selected, the song's information will display on the Progress bar.

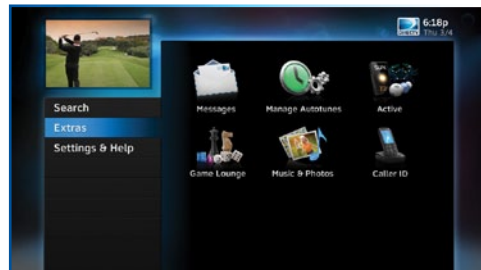

- Select "Photos" to go to the Photos submenu. Select "Browse" to see several photos at once.



- The DVR controls on your remote allow you to stop, play or skip through your music and photos. Press the GREEN button on your remote to toggle among music, photos and video control modes. Pressing the STOP button while in music control mode stops the music from playing and the audio from the current channel is then heard. Pressing the STOP button while in photo control mode stops the display of photos and displays the video from the current channel.



## SPECIAL FEATURES

### GAMESEARCH™

Sports blackouts, a long time source of frustration and confusion for sports fans, occur when a sporting event is not televised in a certain area. But thanks to DIRECTV's cutting-edge technology, whenever you tune to a channel with a blacked-out game, GameSearch™ recognizes the blackout and immediately looks to see if the game is on another channel. If a broadcast of the game is found, GameSearch displays an onscreen message that gives you the option to tune to that channel. If it can't find one, an onscreen message will let you know the game is not available.

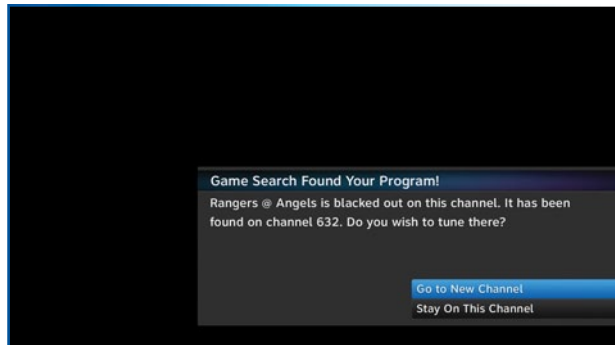

### QUICKTUNE

Use QuickTune to get to your 9 "must see" channels fast! While watching live TV, press the UP arrow on your remote control. A display with spots for 9 channels will appear on screen. To fill the spots, press the GREEN button on your remote control. The channel you are currently viewing will be added to the QuickTune display. After you've made all your picks, press the UP arrow whenever you want to bring up the application. Use the arrow keys to highlight the channel you want to watch and then press SELECT.



**NOTE:** This feature is not available on model H20.



## SCOREGUIDE™

Interactive content, like scores, statistics and other information, is provided on some of our special sports and entertainment channels. Look for an onscreen popup that lets you know when interactive content is available and follow the onscreen instructions to use the interactive features.

## TV APPS

With DIRECTV's exciting FREE TV Apps, like Flickr®, ScoreGuide™, 5-Day Weather Forecast and Webcams, you can view your favorite pictures, get up to the minute scores, check your local weather, see live feeds of popular vacation sights and much more — without missing a second of what you're watching, all at the press of a button. To enjoy TV Apps, your HD Receiver must be connected to the Internet. See Appendix 4, "How to Network your HD Receiver" for instructions.

- Press the Right Arrow button on your remote control to launch TV Apps. Select the DIRECTV App Store icon at the top of the TV Apps Dock and choose the apps you want. You can also go to the online DIRECTV App Store on your computer, at [directv.com/tvapps](http://directv.com/tvapps).
- Whenever you want to access your TV Apps, just press the Right Arrow button and select the App you want to use.

**NOTE:** This feature is not available on model H20.

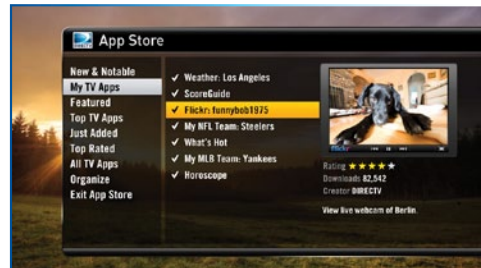
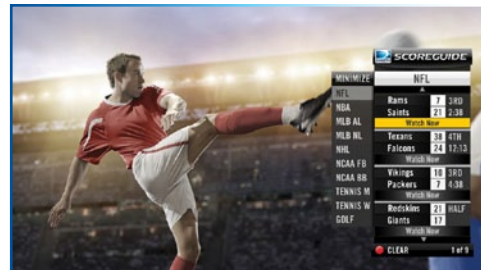

# DIRECTV® WHOLE-HOME DVR SERVICE

With DIRECTV's Whole-Home DVR service and the proper equipment, it's like having a DVR in every room. Now even rooms with HD Non-DVR receivers can schedule and watch recorded programs. Start watching a recorded program in one room, stop it, then continue watching it in another room.

## 1. Network Your Receivers:

When your HD DVR and HD Non-DVR receivers are networked, it allows them to share content. This is typically completed by an installer during your installation appointment. To learn more about upgrade and eligibility requirements, go to [directv.com/wholehome](http://directv.com/wholehome). To get a quick understanding of how recorded content is shared by your household, skip to step 7.

**NOTE:** To access DIRECTV® Whole-Home DVR service functionality, you need a DIRECTV Plus HD DVR receiver (models HR34, HR24, HR20-HR23 with DECA), an additional Whole-Home-capable receiver (models H25, H24, HR24, HR34, H21 with DECA, H23 with DECA, R22 with DECA, HR20-HR23 with DECA) for each TV, a SWiM network, HD Access, DVR service and DIRECTV® Whole-Home DVR service. There is a limit of one remote viewing per DVR at a time. For Whole-Home DVR to function, your receivers should never have an Ethernet cable connected, unless it is connected to a DECA. H24, H25, HR24 and HR34 receivers should never have a DECA installed.



## 2. Activate DIRECTV® Whole-Home DVR Service:

Once DIRECTV® Whole-Home DVR service is activated on your account, press the LIST button on your remote. The message on the right will display, confirming the service has been enabled. Select "Continue".

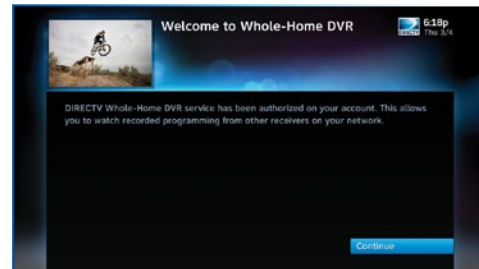

## 3. Name Your Locations:

You'll be prompted to give each receiver a name. We refer to this as "Location." We recommend using a name that you'll easily associate with the room or it's location, such as, "Living Room." The name must be 14 characters or less. You must be at the receiver to assign its name.

After you've assigned a Location Name, you can change it as follows: Press MENU, select "Settings & Help," then "Settings," "Whole-Home" and then "Name Location."

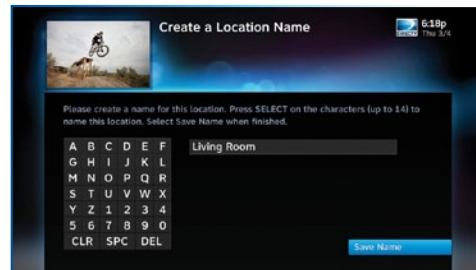

## 4. Set Playlist Sharing Options (HD DVR only):

During initial setup, if the receiver is an HD DVR, you'll be prompted to set the following Playlist sharing options:

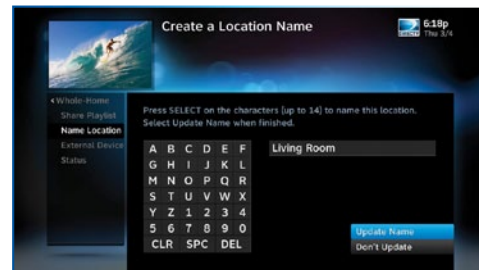

# DIRECTV® WHOLE-HOME DVR SERVICE

## Share Playlist

An HD DVR has the option to share its Playlist with other receivers. Let's say you have an HD DVR in your Den, an HD DVR in your Master Bedroom, and an HD Non-DVR in your Kitchen. If you set Share Playlist to "No" in the Master Bedroom, the other rooms (Den and Kitchen) won't be able to access the Master Bedroom's Playlist.

## Allow Deletion

An HD DVR has the option to prevent another location from deleting programs that were recorded by that HD DVR. In our previous example, if the DVR in the Den is set to allow deletion "From this room only", a person trying to delete a program (recorded in the Den) from the Master Bedroom or Kitchen would be prevented from doing so.

You can change sharing options at any time. Press MENU, select "Settings & Help," then "Settings," "Whole-Home" and then "Share Playlist."

## 5. View Status:

To view the Whole-Home status for all your connected HD DVRs, press MENU, select "Settings & Help," then "Settings," "Whole-Home" and then "Status." This screen indicates if DIRECTV® Whole-Home DVR service is authorized, as well as the Playlist sharing settings for all networked HD DVRs.

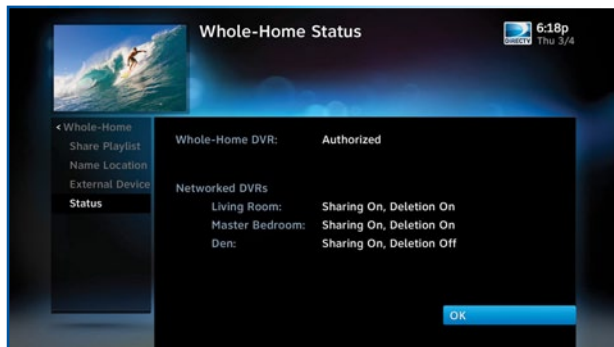
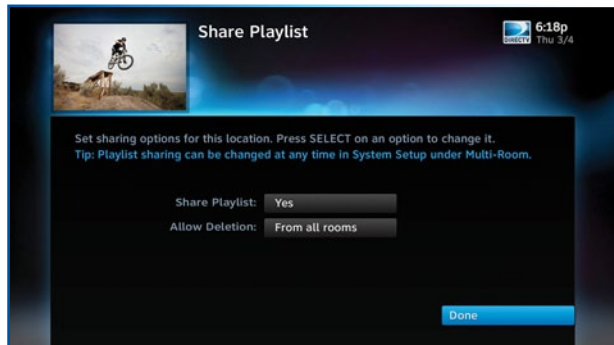

## 6. Record Programs:

If you're in a room with an HD DVR, and you've authorized DIRECTV® Whole-Home DVR service, you'll still record programs in the same way you did before.

If you're in a room with an HD Non-DVR receiver, once you authorize DIRECTV® Whole-Home DVR service you're able to request programs to record.

- To record a show you're currently watching or to record a highlighted program in the Guide, press the orange REC (record) button. A message displays onscreen asking you to select the HD DVR you would like to record on; then select either "Record Once" to record the current episode, "Record Series" to record the entire series or "Do Nothing" to cancel your request.

**NOTE:** Pressing the REC button twice to record a series or pressing it three times to cancel the request - as you can on an DIRECTV HD DVR - does not work on Non-DVR receivers.

You can also schedule a recording from a program's Info screen. To record a program you're currently watching or to record a highlighted program in the Guide, press the INFO button and select either "Record Once" or "Record Series."

- If your recording (requested from a Non-DVR receiver) conflicts with other recordings already scheduled on the DVR, a message will display letting you know that your program cannot be recorded.

**TIP:** Adding a second HD DVR to your DIRECTV® System doubles your recording capacity. Don't worry about having to remember which DVR you recorded your shows on. Whole-Home DVR service keeps things simple by giving you a single, unified playlist of all your recordings on any connected TV.

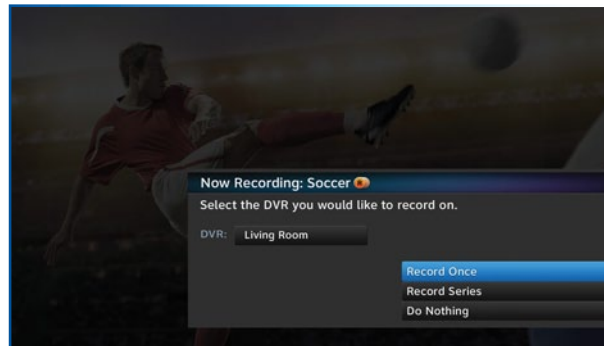

# DIRECTV® WHOLE-HOME DVR SERVICE

- Recordings can be deleted from any connected receiver that has been set up to allow deletion. However, to check the status of scheduled recordings on the To Do List or to change the priority of a series you've scheduled to record, go to the HD DVR, press MENU and select "Recordings," then "Manage Recordings" for options.

## 7. Watch Recorded Programs:

By networking your receivers, the recordings from all the HD DVRs in your household are combined into a "shared" Playlist. The shared Playlist is accessible by all networked receivers, even if the receiver is not a DVR! To access the Playlist, press the LIST button on the remote control, or press MENU, then select "Recordings," then "Playlist." Highlight a show and press SELECT to play. If you've already watched part of the show in another room, you can select "Resume" to pick up where you left off.

You can use any of the DVR control buttons such as PAUSE, FFWD, ADVANCE, etc... while watching your recorded show. You can limit access to programs with Parental Controls. See Chapter 4, "Parental Controls" for details. Your parental controls settings restrict access to both recorded and live programs. Parental controls must be set at each receiver.

To delete a program from your Playlist, use the arrow keys to highlight the desired show and press the RED button.

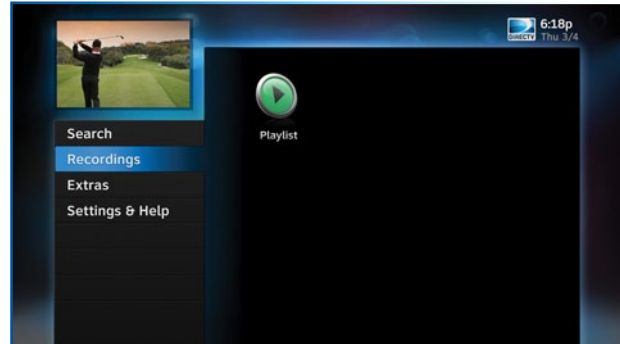

## CHAPTER 4 - SETTINGS & HELP

---

<b>Settings</b> .....	<b>40</b>
Info & Test .....	40
Display .....	40
Audio .....	43
Network Setup .....	44
Remote Control .....	44
Satellite .....	45
Whole-Home .....	45
Power Saving .....	46
Reset .....	46
<b>Parental Controls</b> .....	<b>47</b>
Lock Now .....	47
Unlock Now .....	48
Ratings Limits .....	48
Adult Channels .....	50
Channel Blocks .....	50
Spending Limits .....	51
Viewing Hours .....	51
<b>Favorite Channels</b> .....	<b>52</b>
<b>Help</b> .....	<b>53</b>

## SETTINGS

Press MENU, then select "Settings & Help", then "Settings" for access to DIRECTV Settings screens.

### INFO & TEST

Select "Info & Test" to display the System Info & Test screen. Select "Run System Test" to initiate a test of the tuners, access card, receiver ID and phone line.

**NOTE:** Running the System Test may interfere with live TV and scheduled autotunes.

Select "More System Info" to review your basic system information such as receiver model, receiver ID, access card number, software version, etc.... as well as current receiver settings. This information can be useful during troubleshooting.

### DISPLAY

Select "Display" to access the following options: "Preferences", "Video", "TV Ratio", "TV Resolution", "Captioning" or "Clock". Before you get started, you may want to review Appendix 5, "About High-Definition", which describes HD formats and resolutions.

#### Preferences

These are user interface display settings which include:

**Guide HD Channels:** Choose whether you want the guide to show you HD channels and their duplicate SD channels or to hide the

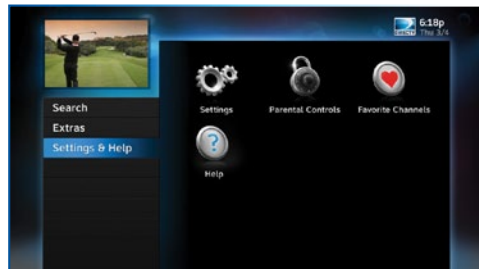



SD duplicates.

**Guide shows:** Select whether you want the first press of the GUIDE button to take you directly to the program guide or to go to the category filter first.

**Language:** Select your preferred onscreen text language.

**Scrolling Effects:** Turn scrolling effects ON or OFF. This affects the appearance of large text areas when they scroll.

**Banner Time:** Set the channel banner time to determine how quickly the banner disappears after moving to a new channel.

**NOTE:** To change your screen format and resolution temporarily, press INFO on your remote, select "Audio/ Video" from the Channel Banner and select "Change Resolution & Format".

## Video

Set your preference for the following screen options: Native, Screen Format and Bar Color.

**Native:** You can turn Native mode ON or OFF. When Native Mode is ON, your TV auto-changes to match the resolution of the program coming into the receiver. For example, if Native mode is ON and a program is being broadcast in 480p, your HD Receiver tells the TV to show it in that same format. If the next program changes to 1080i, the receiver tells the TV to change to that format. Native mode slows down the system's response time to channel changes since the receiver and TV must adjust the picture resolution at every channel change. Because of this, the

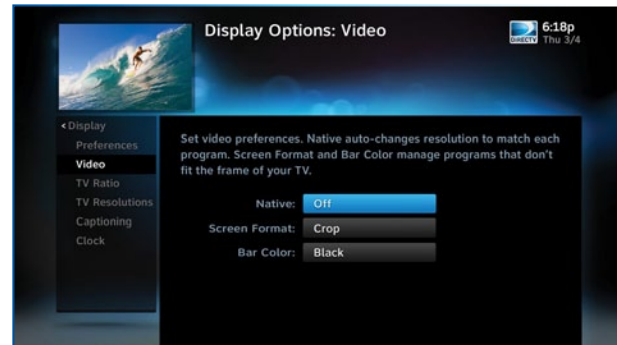

## SETTINGS

default setting is OFF. When Native Mode is OFF, your receiver will display the program at the highest resolution set on the “TV Resolutions” screen.

**Screen Format:** When a program is broadcast in a format that does not fit your TV screen, your receiver adjusts the picture size. Options include Original Format, Pillar Box (Widescreen 16:9 HDTVs only), Letterbox (Standard 4:3 TVs only), Stretch and Crop. If you’re watching a widescreen movie on a Standard 4:3 TV, you may want to choose “Letterbox” which places bars on the top and bottom of the screen. If your HDTV is 4:3 aspect ratio, you may want to “Crop” or cut off the content at the left and right side of the screen while preserving the proportion of the picture that remains. You can also “Stretch” the picture vertically or horizontally to fill up the screen.

**Bar Color:** Select the Bar Color option to set the color of the bars displayed when you view programming in Letterbox or Pillar Box modes.

### TV Ratio

Set the aspect ratio that matches your TV. Options are Standard 4:3 or Widescreen 16:9.

### TV Resolutions

Select the resolutions your TV can support so your receiver can pass the proper signal. To find the resolutions your TV supports, check the user’s guide that came with your TV. If you select a resolution your TV doesn’t support, the receiver will reset the resolution after a few seconds.



## Captioning

On HD receivers, select “Captioning” to turn closed captioning ON or OFF, and to select the font style, size and color for the display of captions.

## Clock

Select “Clock” to set your time zone and whether you want the receiver to show Daylight Savings time or not.

## AUDIO

Select “Audio” to make a persistent change to your audio settings. Audio options include:

**Language:** Select your preferred audio language, i.e. English, Spanish, Chinese, etc...

**Sound Effects:** Select the volume of sound effects

**Dolby® Digital:** Select whether you want Dolby Digital audio output ON or OFF, i.e. for a surround sound system.

Not all TV programs deliver Dolby Digital 5.1 audio. Look for the Dolby Digital icon in the program description and Channel Banner. HD channels include 5.1 surround sound when available from the programmer. “Dolby” and the double-D symbol are trademarks of Dolby Laboratories.

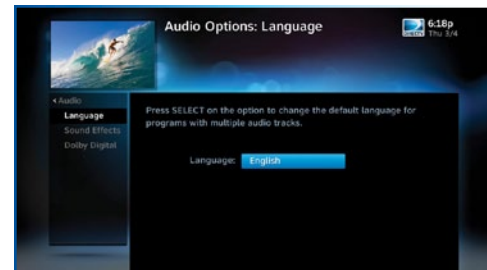

# SETTINGS

## NETWORK SETUP

Select “Network Setup” to configure and test the connection of your receiver to the Internet. See Appendix 2 for details.

**NOTE:** This option is not available on model H20.

## REMOTE CONTROL

When the MODE switch on your remote is in the left-most position, it controls your DIRECTV receiver. However, you can also program the AV1, AV2 and TV positions to control other equipment such as your TV, DVD, VCR or Stereo. From System Setup, select “Remote Control” and then “Program Remote.” It is helpful to know the model number as well as the brand of the equipment to produce the best results when programming the remote. To clear current AV1, AV2 and TV settings use the “Reset Remote” option.

## IR/RF SETUP

Certain remote control models feature RF (radio frequency) capability. Refer to the model number printed on the top left corner of your DIRECTV Remote Control. Look for the letter(s) “R” or “RB” at the end of the model number which indicates that the

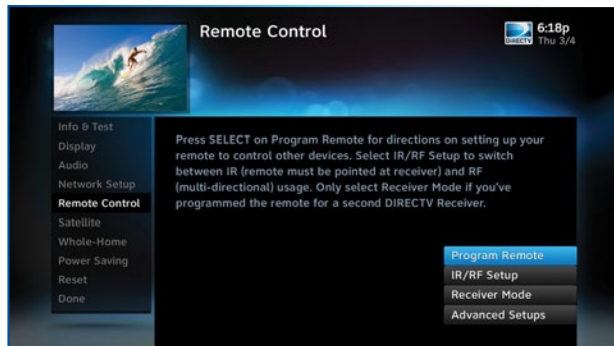

remote supports radio frequency. To change your remote method of transmission from Infrared (IR) signals to RF, select "Remote Control" and then "IR/RF Setup". While IR transmission requires a clear line of sight to the front of the receiver, RF transmission lets you put your receiver inside a cabinet or behind solid doors and still be able to command it from up to 200 feet away.

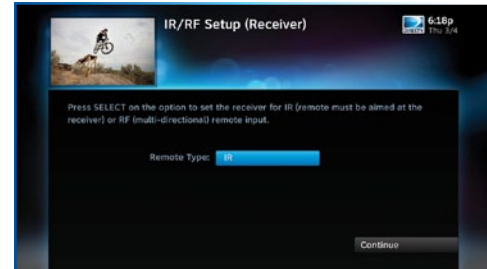

## SATELLITE

This option is used by installers when your system is initially set up; you should not have to use it. However, you can use this screen to view the satellite signal strength your receiver is getting or to repeat the satellite setup procedure.



## WHOLE-HOME

If you're using DIRECTV® Whole-Home DVR service, use this option to name this receiver location. Select "Whole-Home", then "Name Location" and follow the onscreen instructions. To learn more, read the "DIRECTV® Whole-Home DVR service" section in Chapter 3. Use the "External Devices" option to allow mobile devices to access content on your DIRECTV receiver, including the ability to see the info for the currently tuned program, and tune to a channel. The "Status" option shows whether your account is authorized for Whole-Home DVR service, and how many receivers are found on your network.

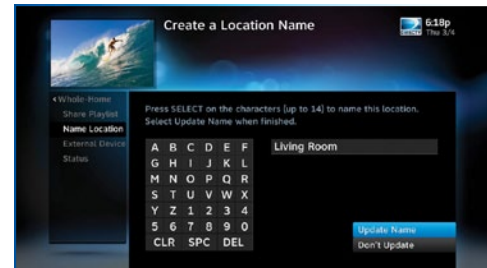

# SETTINGS

## POWER SAVING

Some DIRECTV Receivers are Energy Star certified, meaning they include features that reduce electrical consumption. The Power Saving option automatically puts these receivers into Standby mode when there is no activity on your remote for 4 hours. When the feature is ON, a message will display to warn you before the receiver goes into Standby mode.

## RESET

The Reset screen lets you restart the receiver, reset to factory defaults, or reset everything.

“**Restart Receiver**” is the same function as pressing the red reset button behind the access card door on the front of the receiver. This option does not affect your settings and scheduled autotunes.

“**Reset Defaults**” erases all of your personal preference items, such as parental controls, favorites, language and scheduled autotunes, and restores the receiver configuration to how it was set at the factory.

“**Reset Everything**” Completely erases everything from system memory and starts over like a new receiver, starting over with Guided Setup.

**NOTE:** If Parental Controls are locked, you must enter your password to reset the receiver.



To review or update your Parental Controls settings, press MENU, select “Settings & Help”, then “Parental Controls”. You can also access Parental Controls by pressing INFO, then selecting “Parental”, then “Parental Controls”.

Parental Controls enable parents to place certain restrictions on just who’s watching what, and requires a passcode to view restricted programming. Whether it’s for mature content, spending amounts, or even the number of hours of TV watching allowed, you’re always able to keep limitations where you want them for the whole family. The system default is “unlocked” for all categories.

## LOCK NOW

After setting the restrictions you want (see below for options), choose “Lock Now” from the left menu. You’ll be asked to create a passcode. This passcode will be your entry to unlocking and adjusting limitations in the future.

**NOTE: If you forget your passcode, call 1-800-531-5000 to reset it. You must be the registered account holder and have your account number.**

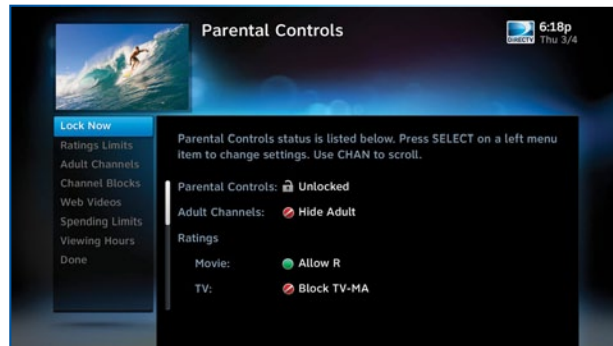

## PARENTAL CONTROLS

### UNLOCK NOW

When parental controls are locked, a message appears if you try to tune to a restricted program explaining why the program is blocked. To temporarily unlock a particular program select “Unlock Now” and enter your passcode. Making multiple entries aimed at guessing the passcode is discouraged by a time delay; each invalid passcode entered lengthens the delay for subsequent entry by one second.

For more unlock options, press MENU, select “Settings & Help” then select “Parental Controls.” Various options for removing restrictions temporarily or permanently will appear. Select one and enter your passcode. You can also unlock Parental Controls by pressing INFO while watching TV. Select “Parental” then “Unlock All” and enter your passcode.

**NOTE:** If you have Parental Controls set and temporarily unlocked, turning the receiver off will turn parental controls back on.

### RATINGS LIMITS

The Ratings feature lets you set ratings limits for Movies, TV and unrated shows. From the left menu, select “Ratings Limits,” then select either Movies, TV or Other.

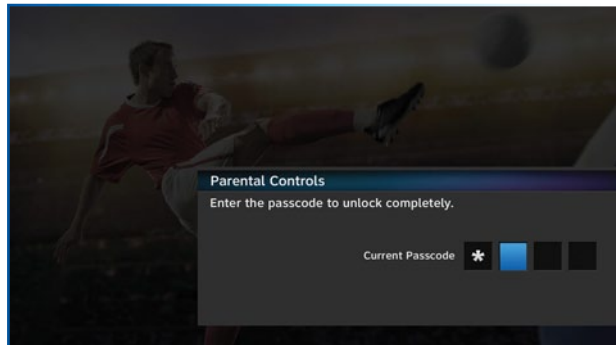



## Movies

Select the button next to the ratings limit you wish to impose. Brief descriptions of the ratings appear for your guidance.



## TV Programs

Highlight and select the TV ratings limit you desire. In addition to allowing or blocking shows by TV rating (i.e. TV-MA), you can also set ratings limits for particular types of content such as, Fantasy Violence (FV), Dialogue (D), Language (L), Sexual Content (S) and Violence (V). A description of each content type displays when highlighted.



## Other Shows

Block or allow programming that has no rating — such as news and sports.

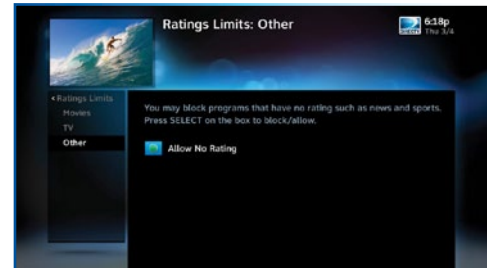

# PARENTAL CONTROLS

## ADULT CHANNELS

Select "Adult Channels" then press SELECT again to completely hide adult channels in the program guide, Manage Autotunes screens, and when channel surfing.

Pressing SELECT on "Show Adult" toggles between Show Adult and Hide Adult.



## CHANNEL BLOCKS

Prevent children from viewing pre-selected channels. Select "Channel Blocks". Scroll down the channel list and select those you wish to block. You can also key in channel numbers for quicker access. Use "Block All" or "Allow All" to save time.

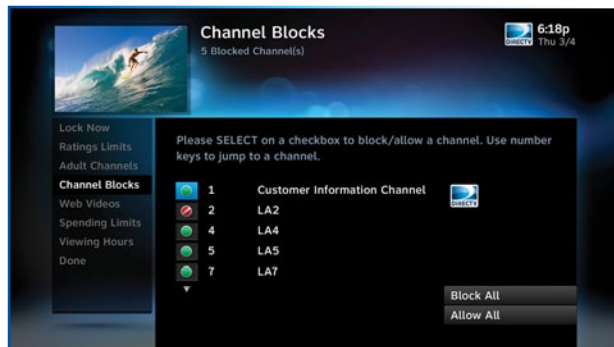

## SPENDING LIMITS

Limit the amount that can be spent on a single purchase or Pay Per View event. Select "Spending Limits". Then enter your preferred spending dollar limit using the numbers on your remote.

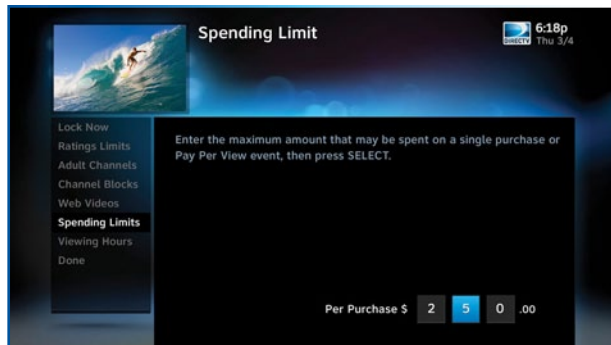

## VIEWING HOURS

Specify days and times when TV watching is allowed in your household. Select "Viewing Hours", then select the start times and durations for viewing. You can set hours based on "school nights" -- Monday- Thursday - and/or weekend nights -- Friday-Saturday, and Sunday.



## FAVORITE CHANNELS

Create lists of your favorite channels. Use a list to see only those specific channels listed in the guide as well as, when you're channel surfing in live TV. You can create up to two custom lists on this receiver. You can also choose "Channels I Get" to see only the channels that are in your DIRECTV programming package.

Press MENU on your remote, select "Settings & Help," then "Favorite Channels." If you haven't created a Favorites list, the "Setup Custom 1" and "Setup Custom 2" options will be displayed. Select the one you want and follow the onscreen instructions to create and name your list.

Selecting a Favorites list makes it active and hides the display of all other channels in the guide. From the program guide, press the YELLOW button on your remote, select "Change Favorites List" and then select the list you want to make active. The name of the currently selected Favorites list is displayed in the bottom right of the program guide screen to remind you which list you are currently using. To return to displaying all channels, press the YELLOW button while in the guide, select "Change favorites list", then select "All Channels".

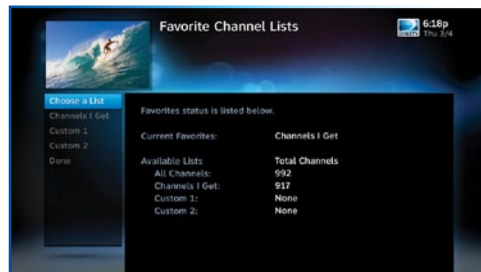

Press MENU, then select “Settings & Help”, then “Help” for access to the DIRECTV onscreen Help feature. These screens show concise versions of the text from this user guide, so you can figure out how to use your receiver right on your TV screen. For model H20, press MENU, select “Customer Care & Help” and then select “Help”.

Tune to Channel 1 to access the interactive DIRECTV Customer Information Channel. Watch videos on a variety of topics, such as your remote control, receiver features, and troubleshooting. To exit the Customer Information channel, press CHAN UP/DOWN, press GUIDE, or enter a channel number to tune to.

You can also find answers to all your questions on DIRECTV’s Answer Center at [support.directv.com](http://support.directv.com).

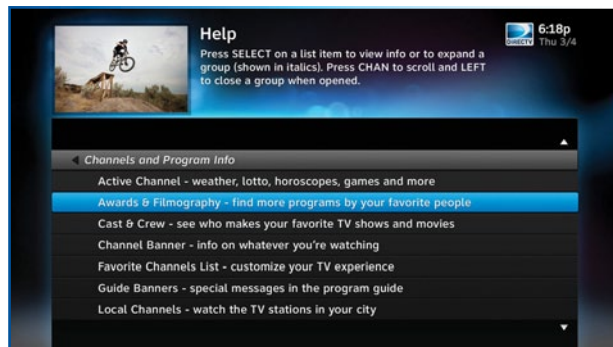
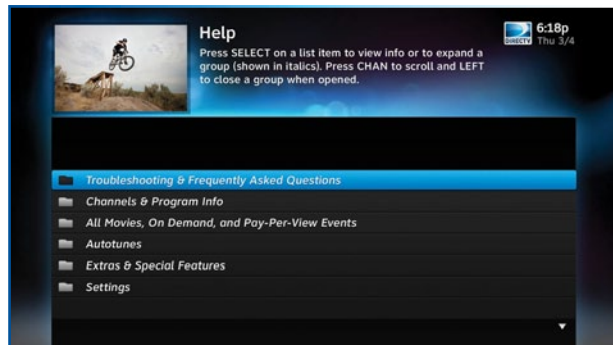



## CHAPTER 5 - TROUBLESHOOTING & FAQs

---

<b>Troubleshooting Tips</b> .....	<b>56</b>
Reset Your Receiver .....	56
Reauthorize Your Receiver .....	56
Onscreen Messages .....	57
System Software Updates .....	57
Run the System Test .....	58
<b>Frequently Asked Questions</b> .....	<b>59</b>

## TROUBLESHOOTING TIPS

### RESET YOUR RECEIVER

Many problems can be corrected by performing a simple reset of the DIRECTV® Receiver. If you experience frozen audio or video, a blank screen, or the receiver won't respond to front panel button or remote control, you can reset your receiver with the following steps:

- Press the red RESET button. Depending on your model of receiver, this will be either behind the access door on your receiver's front panel, or on the right side. After pressing the RESET button, you'll need to wait a few minutes for program guide information to be acquired.
- If the problems persist, try unplugging the power cord of the DIRECTV® Receiver for 15 seconds, then plug it in again.

### REAUTHORIZE YOUR RECEIVER

If your receiver displayed the message "722 - Service Expired," try reauthorizing your receiver. On a computer, go to [directv.com/reauthorize](http://directv.com/reauthorize) and follow the onscreen instructions. You will need to be logged into your account on [directv.com](http://directv.com) to complete this process.

Running the System Test (later in this section) can also help you diagnose and solve many common problems.

#### HD Receivers



Reset Button

*(Your equipment may not look exactly like the model illustrated.)*

#### HD Receiver (model H25)



Reset Button



## ONSCREEN MESSAGES

There may be times when you see an onscreen message similar to the one on the right. The top line of the message gives a brief description of what causes the onscreen message to display, while the second line displays instructions to follow. Most onscreen messages supply a code in parentheses. That code is used by DIRECTV Customer Service to help troubleshoot your call.

The message at the right shows an example of trying to view a channel that you have not purchased or that is not in your programming package. To resolve the situation, call **Customer Service at 1-800-531-5000** and mention the code when prompted.

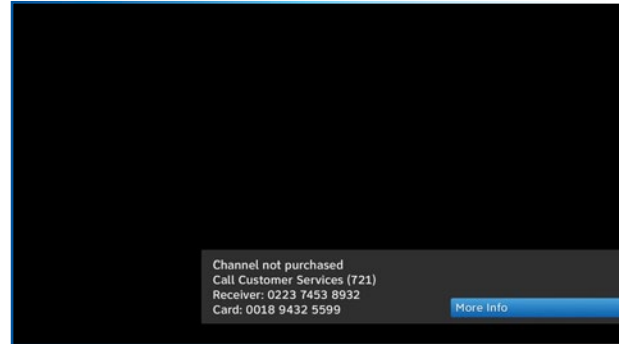

## SYSTEM SOFTWARE UPDATES

DIRECTV periodically sends system software updates to your receiver to improve performance and upgrade features and functions. These updates will occur automatically. The receiver will give you the option to download software "now" or "later." Software downloads take just a few minutes and should be allowed to proceed when possible. When a download is in progress, channels, interactive functions and applications will temporarily become unavailable. After the download is complete, the receiver may reset itself. Once the receiver download and/or reset is complete, you can resume using as normal.

# TROUBLESHOOTING TIPS

## RUN THE SYSTEM TEST

The System Test allows you to run a basic diagnostics check on your DIRECTV Receiver.

First make sure that:

1. All connections — jacks, cables, etc. — are in place correctly. See Appendix 2, “Connections to TV and Equipment” for more information.
2. There are batteries in the remote control and they are working correctly.
3. The access card is inserted in the DIRECTV® Receiver.

Follow these steps to run the diagnostics system test on your DIRECTV® Receiver:

1. Turn on your TV and the DIRECTV® Receiver.
2. Slide the mode switch to the DIRECTV position and, then press MENU.
3. Select “Settings & Help”.
4. Select “Settings” then “Info & Test”.
5. Select “Run System Test”.
6. If your system does not pass the System Test, check any of these potential trouble areas: cabling, pointing the satellite dish, phone connection and access card.
7. If you continue to have problems, call DIRECTV Customer Service at 1-800-531-5000.
8. You should run a system test several times before concluding that there is a problem. Occasional fluctuations in the phone line or satellite signal can give temporary false readings.

## Why does my Progress Bar freeze while acquiring guide data / data from satellite?

While the “Acquiring Guide Data” or “Acquiring Data From Satellite” message is on the screen, progress freezes during download.

### Possible Causes:

- This may be normal. After five minutes, the screen saver will display. Press any key on the remote to see the progress bar again.
- May happen if your satellite dish isn't adjusted properly.

### Solution:

- If satellite data acquisition still does not move forward, press the RESET button behind the access panel door on the front of the DIRECTV® Receiver and wait for program guide information to be acquired.

## Why does my DIRECTV® Receiver turn on or change channels unexpectedly?

Your receiver changes to a different channel without a remote control command.

### Possible Causes:

- A scheduled autotune may be about to begin, so the receiver is changing channels to tune the show as requested.
- Your TV's timer may have been activated.

### Solution:

- Check your To Do List to see if there are other scheduled autotunes. Press MENU, select “Extras,” then “Manage Autotunes”, then “To Do list”.
- Check your TV owner's manual to turn off the TV's timer.

## FREQUENTLY ASKED QUESTIONS

### Why is my screen blue, black, gray or snowy?

Your TV displays a blue, black, gray or snowy screen.

#### Possible Causes:

- Your TV and/or your receiver are not powered on.
- The DIRECTV® Receiver and most TVs and VCRs let you toggle between different video sources. Your TV may be on a different input source than what you are trying to view.
- Your TV may not support the selected HD resolution from your receiver.

#### Solution:

- Check that the DIRECTV® Receiver and TV are both powered on.
- If you don't see your DIRECTV picture, verify the input your TV is set to by turning the TV on and off. Most TVs display the input in the upper right- or left-hand corner. If the input is set to something other than your DIRECTV receiver, toggle through the inputs with the "input" button on the DIRECTV remote (if programmed) or TV remote until you get your picture. (If the DIRECTV remote is not working for the TV it may need to be programmed.)

If the TV remote is not available:

1. Find the Input or Source button on your TV and press it. It may be on the front panel, sides, bottom, or top edge of your TV.
  2. Slowly set the TV to each input option, one at a time. Sometimes it takes a second or two for the input to switch, so don't proceed too quickly.
  3. Set the TV to whichever input gives a picture.
- If you see a snowy screen and are using a coax connection to connect to the TV, make sure your TV is on channel 3 or 4.
  - Press the TV/VCR button on the VCR remote or on the VCR's front panel.

- If problems persist, turn off all equipment connected to your TV, wait a few minutes, then turn the DIRECTV® Receiver back on.
- Check your connections and cables.
- Check the HD output resolutions and deselect those not supported by your TV. For 1080p programs, some TVs do not support the 24 frame-per-second rate DIRECTV provides. Press the RES button on your receiver's front panel to change the resolution to one your TV supports.

### Why won't my DIRECTV® Receiver turn on?

Your receiver won't turn on with either the remote or from the front panel.

#### Possible Causes:

- Remote batteries have insufficient charge.
- Receiver or power strip is not plugged in to a power source, or power cord is not plugged in to receiver.
- Wall outlet is not providing power.

#### Solution:

If your receiver won't turn on, the problem may be with the receiver itself, or with the remote control. Please try the following:

To check the Receiver:

- Verify the detachable power cord is plugged into the back of the DIRECTV® Receiver and the wall outlet.
- Check the outlet or power strip to make sure it is "live" by plugging in something else.
- Try plugging receiver into a different wall outlet.
- Make sure the outlet is not controlled by a wall switch.
- Unplug receiver for five minutes, and then plug it in again.
- If your receiver is plugged into a power strip, check the power strip and reset by pressing its reset button. Make sure receiver is

## FREQUENTLY ASKED QUESTIONS

plugged into a power strip outlet that has continuous power. Some power strip have energy saving ports that only operate when a device is plug in and powered on.

To Check the Remote:

- Press the power button on the front panel. If the receiver turns on, issue is with remote.
- Make sure the remote control MODE switch is in the left-most position (DIRECTV Mode), and press PWR (power key) or press POWER button on the front panel of the receiver.
- Make sure remote batteries have sufficient charge. Green light should be solid green when the PWR button on remote is pressed. If the light blinks several times slowly, replace the batteries. If there is no light, make sure batteries are inserted with the positive and negative ends in the proper directions. Otherwise replace batteries.
- Make sure nothing is blocking the IR sensor on the on the receiver. Remote must be pointed at receiver, unless it is capable of RF and had been set up as RF.

### Why did my DIRECTV® Receiver turn off while playing?

Your receiver turns off unexpectedly.

Possible Causes:

- Excessive heat may have caused the receiver to go into a standby state.
- Electronic protection circuit may have been activated due to a power surge.
- You may have blown a circuit breaker or be experiencing a power outage.
- Parental viewing limits may have been activated on your DIRECTV® Receiver.

Solution:

- Ensure that your receiver has plenty of ventilation and that nothing is on top of the receiver.

- Wait 30 seconds for internal circuits to reset, then turn receiver back on.
- Consider using a line conditioner or surge protector.
- Consult an electrician if the problem is frequent or severe, especially if other household appliances or electronics are affected.
- If parental limits are active, turn your DIRECTV® Receiver back on and enter your parental lock code at the prompt.

### What to do about temporary loss of the satellite signal, “frozen” picture, or picture breaking into blocks / pixels?

The image on your screen is frozen, blocky, or you see a message that says “Searching for Satellite Signal (x771).

#### Possible Causes:

- Severe weather (rain, snow, hail etc.) may cause this issue.
- There may be an obstruction to your dish (debris, snow, ice, etc.) or a building or tree that blocks your line of sight to the satellite.
- There may be a problem with the cables running from your satellite dish to your DIRECTV® Receiver.
- If the picture is frozen, blocky, or pixels, there may be a problem with the transmission from the source.

#### Solution:

- Weather issues are usually temporary. Wait for the weather to clear and your signal should return to normal.
- If there are no weather problems in your area, reset your DIRECTV® Receiver using the red RESET button behind the door on the front of the receiver or by unplugging the receiver for 15 seconds and then plugging it back in.
- You can also check all the cable connections between your DIRECTV® Receiver and the satellite dish for loose or broken connections.
- If the problem is coming from the program source (for example, you see the problem on one channel, but not on any others), wait for the broadcasting channel to resolve the issue.

## FREQUENTLY ASKED QUESTIONS

- If there are obstructions blocking the dish's clear view of the satellite, you should contact a professional to remove them or a DIRECTV Installer at 1-800-531-5000 to relocate your dish.
- If your signal strength is lower than 70 (60 or lower on HD receivers) on most transponders in good weather, contact a professional installer to realign your dish or call us at 1-800-531-5000.

### What to do about partial programming loss; channels missing from the Guide; channel in the Guide that I can't tune to?

Your Program Guide is missing channels, or you are unable to use the guide to tune to a channel.

#### Possible Causes:

- The channels might be excluded from the Favorites list currently in use.
- Your satellite dish may be incorrectly configured.
- Your receiver information may need to be refreshed.

#### Solution:

- To change your Favorites List, press GUIDE on the remote, then press the YELLOW button and select "Change favorites list," then "All Channels."
- Enter the channel number using the number pad on the remote control.
- Check the dish type set in your receiver's preferences: Press the MENU key on the remote control, select "Settings & Help", "Settings", "Info & Test", and then "More System Info". Scroll down to Dish Type to see if it is correct. If not, select "Satellite" from the left menu, then "Repeat Satellite Setup." From the Satellite Dish Type screen, make sure the proper dish type is selected.
- To refresh your receiver information, go to [directv.com/reauthorize](http://directv.com/reauthorize). You will need to be logged into your account on [directv.com](http://directv.com) to begin this process.



## Why are my video and audio out of sync?

The audio track does not match the lip movements on the screen.

### Possible Causes:

- Problem with how the program was produced or how it was sent to DIRECTV for broadcast.
- Your surround sound system may be out of sync, or may be set up incorrectly.

### Solution:

- Change the channel on your DIRECTV® Receiver. This may re-sync the audio.
- Rewind the program for about 5 seconds, then fast forward to live programming.
- Try replacing or switching the cables between your surround sound system and your DIRECTV Receiver. Refer to your surround sound system's manual for assistance.
- If the issue continues, reset your DIRECTV® Receiver. Press the RESET button behind the access panel door on the front of the DIRECTV® Receiver. You can also press MENU, select "Settings & Help," then "Settings." Select the "Reset" item from the left menu and follow the onscreen instructions.

## Why is there no Audio with Picture?

You can see a picture from your DIRECTV® Receiver, but there is no sound.

### Possible Causes:

- A setting (such as mute or volume) may have changed on the receiver or your TV.
- The cables between your TV and the receiver may not be connected properly, or there may be a problem with an external stereo or surround sound system.

## FREQUENTLY ASKED QUESTIONS

### Solution:

- Verify “MUTE” button is not activated.
- Raise or lower the volume. Did volume meter display on TV? If not, your remote may not be programmed for your TV. See Chapter 4, “Settings & Help:Settings:Remote Control” to program your remote.
- Test sound on TV by changing the input to another source, such as a DVD player, game box, or antenna.
- If connected to stereo or surround sound system, verify components are on and set to the correct mode, and that audio cables are secure and connected correctly.
- If the issue continues, reset your DIRECTV® Receiver. Press the RESET button. Depending on your model of receiver, this will be either behind the access door on your receiver’s front panel, or on the right side. You can also press MENU, select “Settings & Help,” then “Settings.” Select the “Reset” item from the left menu and follow the onscreen instructions.

### Why is Caller ID not working?

Caller ID information isn’t showing on your TV screen when phone calls come in.

#### Possible Causes:

- You don’t subscribe to Caller ID service through your local phone company.
- The Caller ID feature in your DIRECTV® Receiver is turned off. See “Caller ID” in Chapter 3.
- You are using a wireless phone jack, which usually will not transmit Caller ID information.

#### Solution:

- Contact your local phone company to subscribe to Caller ID service.
- Select “Caller ID” from the main menu to turn on your Caller ID notifications.
- Verify that your wireless phone jack transmits Caller ID information. If not, connect a standard phone cable to your receiver or replace your wireless phone jack.

## What can I do if I'm having problems with my Remote Control?

- Check that nothing is between the remote control and the remote sensor.
- Make sure the remote control MODE switch is in the left-most position (DIRECTV Mode). Slide the MODE switch on the remote to the DIRECTV position so the remote will control the DIRECTV® Receiver.
- Check the batteries in the remote control. They may be weak, dead or installed incorrectly. Try replacing batteries.
- If you're entering a channel number that is less than four digits long, the receiver might wait two seconds before tuning to the channel. Press ENTER after entering a channel number to tune immediately.
- If you are trying to operate a device other than the DIRECTV® Receiver that you have programmed the remote to control, make sure you first slide the MODE switch to the mode that is programmed for that device (AV1 or AV2). The indicator light for the component you're trying to control should light up when you press a valid key for that component. If it doesn't, make sure the MODE switch is in the correct position.
- Make sure the device you are trying to control has been programmed to your DIRECTV Remote Control. See Chapter 4, "Settings & Help: Settings" for instructions.
- If the green indicator light on the remote control starts flashing, the batteries in the remote control are running low and should be replaced soon. You may also see an onscreen message that the batteries are low. Note that when you replace the batteries, you should not have to reprogram your remote to control other devices unless the batteries have been completely dead for a month or more.

## Why can I not see DIRECTV menus and screens on my TV? OR

Why do I see a message that says, "This TV or its cables are not HD. To see screen graphics, press the RES Key on the front of the receiver until this message no longer appears"

When the receiver resolution is set to 720p, 1080i, or 1080p, DIRECTV screens and menus ("user interface") will not appear on Standard Definition (SD) outputs. A message is displayed to notify you that the resolution setting needs to be changed.

## FREQUENTLY ASKED QUESTIONS

### Possible Causes:

- You have connected your receiver to your TV using both a High Definition output (HDMI) and Standard Definition (SD) outputs (S-Video, Component (Red/Yellow/White), or Coaxial) on the same receiver.
- You are using SD outputs (S-Video, Component (Red/Yellow/White), or Coaxial) and have the receiver set to HD resolutions such as, 720p, 1080i or 1080p.

### Solutions:

- Change the receiver resolution to 480i or 480p by pressing the RES button on the front receiver panel until 480i or 480p is selected.
- Uncheck all resolutions except 480i or 480p on the TV Resolutions menu. Press MENU, select "Settings", "HDTV" and then "TV Resolutions". Follow the onscreen instructions.
- Turn "Native" Off. Press MENU, select "Settings", "HDTV", "Video", then "Native", and follow the onscreen instructions.

## CHAPTER 6: WARRANTY AND OTHER INFO

---

<b>Limited 90-Day Warranty .....</b>	<b>70</b>
Who is covered? .....	70
What is Covered? .....	70
What is Excluded? .....	71
Make Sure You Keep... ..	71
Before Requesting Repair Service... ..	71
To Get Warranty Service... ..	72
Before Requesting Repair Service... ..	72
<b>DIRECTV PROTECTION PLAN .....</b>	<b>73</b>
<b>FCC Customer Information .....</b>	<b>74</b>
<b>TERMS AND CONDITIONS FOR USE OF SOFTWARE ("TERMS") .....</b>	<b>77</b>

## LIMITED 90-DAY WARRANTY

DIRECTV warrants your DIRECTV® Receiver (Models D and H) and any included accessories against defects in material or workmanship for a period of ninety (90) days after the date of acquisition.

### WHO IS COVERED?

You must have proof of acquisition to receive warranty service. A receipt or other document showing that you acquired the product is considered proof of acquisition. THIS LIMITED WARRANTY EXTENDS ONLY TO THE ORIGINAL CONSUMER ACQUIRER OR ANY PERSON RECEIVING THE DIRECTV® RECEIVER AS A GIFT FROM THE ORIGINAL CONSUMER ACQUIRER AND TO NO OTHER ACQUIRER OR TRANSFEREE. THIS WARRANTY DOES NOT EXTEND TO COMMERCIAL USERS. THIS PRODUCT IS NOT AUTHORIZED FOR USE OUTSIDE THE UNITED STATES AND ANY SUCH USE VOIDS THIS WARRANTY.

### WHAT IS COVERED?

Warranty coverage begins the day you acquire the product. For ninety (90) days from the acquisition date, at the option of DIRECTV, the DIRECTV® Receiver will be repaired or replaced with a new, repaired, refurbished or comparable product (whichever is deemed necessary) if it becomes defective or inoperative. This exchange is done without charge to you for parts and labor. You will be responsible for the cost of shipping to and from the location designated by DIRECTV. If DIRECTV cannot reasonably repair or replace the Receiver then DIRECTV may, at its sole discretion, refund the price you paid for the product or the current retail price of the product.

All products, including replacement products, are covered only for the original warranty period. When the warranty on the original product expires, the warranty on the replacement product also expires. After ninety (90) days from the date of acquisition, you pay for the replacement of all parts, and for all labor charges.

SOME STATES DO NOT ALLOW LIMITATIONS ON HOW LONG AN IMPLIED WARRANTY LASTS, SO THE ABOVE LIMITATION MAY NOT APPLY TO YOU.

## WHAT IS EXCLUDED?

Your warranty does NOT cover:

Labor charges for installation or setup of the product.

Installation, performance of, or repair of: audio/video cabling, telephone line, or accessory attachments used with the product.

Product replacement because of misuse, accident, lightning damage, unauthorized repair, or other cause not within the control of DIRECTV. Incidental or consequential damages resulting from the product. **SOME STATES DO NOT ALLOW THE EXCLUSION OF INCIDENTAL OR CONSEQUENTIAL DAMAGES, SO THE ABOVE EXCLUSION MAY NOT APPLY TO YOU.** Any modifications or other changes to the product, including but not limited to software or hardware modification in any way other than as expressly authorized by DIRECTV will void this limited warranty. Except in the case of hardware or software provided by DIRECTV, installing software modifications, "hacks" or utilizing service access or "back doors" will void this limited warranty.

Reception transmission problems caused by signal conditions, telephone line, or cable or antenna systems outside the unit. A product that has been modified or adapted to enable it to operate in any country other than the country for which it was designed, manufactured, approved and/or authorized, or repair of products damaged by these modifications. A product used for commercial or institutional purposes.

DIRECTV makes no warranty that the access connection will be a local (not long distance) phone call.

The continued provisioning of any of the programming and other services delivered through the Receiver including but not limited to television programming, show information, program guide data, and scheduling information.

## MAKE SURE YOU KEEP...

Please keep your receipt or other document showing proof of acquisition. Attach it to this User Guide and keep both nearby. Also keep the original box and packing material in case you need to return your product.

## BEFORE REQUESTING REPAIR SERVICE...

Please check the troubleshooting section of this guide. This may save you a call to DIRECTV Customer Care.

# LIMITED 90-DAY WARRANTY

## TO GET WARRANTY SERVICE...

Warranty service will be provided by DIRECTV. If you believe you need service for your Receiver, contact DIRECTV at 1-800-DIRECTV. A representative will go through a diagnostic checklist with you. If it is determined that the product needs to be returned for service or exchanged, you will receive a return authorization number. The representative will give you complete shipping details.

## BEFORE REQUESTING REPAIR SERVICE...

To obtain out-of-warranty service contact DIRECTV at 1-800-DIRECTV for information on the possibility of and any costs for repair or replacement of out-of-warranty products.

ALL WARRANTIES IMPLIED BY LAW, INCLUDING ANY IMPLIED WARRANTIES OF MERCHANTABILITY AND FITNESS FOR A PARTICULAR PURPOSE ARE EXPRESSLY LIMITED TO THE DURATION OF THIS EXPRESS LIMITED WARRANTY.

WITH THE EXCEPTION OF ANY WARRANTIES IMPLIED BY THE LAW OF ANY STATE OF THE U.S.A., THIS EXPRESS LIMITED WARRANTY IS EXCLUSIVE AND IN LIEU OF ALL OTHER WARRANTIES, GUARANTEES, AGREEMENTS AND SIMILAR OBLIGATIONS OF DIRECTV. REPAIR OR REPLACEMENT AS PROVIDED IN THIS LIMITED WARRANTY IS THE EXCLUSIVE REMEDY UNDER THIS LIMITED WARRANTY. IN NO EVENT WILL DIRECTV BE LIABLE FOR ANY AMOUNT GREATER THAN THE RETAIL PRICE OF THE DIRECTV® Receiver. DIRECTV SHALL NOT BE LIABLE FOR ANY INCIDENTAL OR CONSEQUENTIAL DAMAGES FOR BREACH OF ANY EXPRESS OR IMPLIED WARRANTY ON THE DIRECTV® RECEIVER.

SOME STATES DO NOT ALLOW LIMITATIONS ON WARRANTIES, SO THE ABOVE LIMITATIONS MAY NOT APPLY TO YOU. THIS WARRANTY GIVES YOU SPECIFIC LEGAL RIGHTS. YOU MAY HAVE OTHER RIGHTS WHICH VARY FROM STATE TO STATE.

**DIRECTV**  
2230 E. Imperial Hwy  
El Segundo, CA 90245  
1-800-DIRECTV



Safeguard your DIRECTV® System with the ultimate in professional technical service. For a low monthly fee, the DIRECTV PROTECTION PLAN covers the components of your entire DIRECTV® System, giving you affordable peace of mind and comprehensive support to ensure that you and your family enjoy nonstop DIRECTV® entertainment.

## DIRECTV PROTECTION PLAN Benefits

Your DIRECTV Limited Warranty provides certain remedies for this receiver during the stated coverage term. The DIRECTV PROTECTION PLAN provides comprehensive coverage for your DIRECTV® System, including:

<b>Professional In-home service calls when needed</b>	<b>Dedicated Technical Support 24-hour a day</b>
<b>Power surge related repairs including those caused by lightning</b>	<b>Unlimited dish antenna alignments</b>
<b>Cables, switches, and associated wiring throughout your home</b>	<b>Replacement of defective receiver equipment (if problem can not be resolved over the phone)</b>
<b>Defective remote control replacements</b>	<b>All parts and labor for repair</b>

Sign up today for the DIRECTV PROTECTION PLAN by calling 1-800-DIRECTV

The DIRECTV PROTECTION PLAN is offered by AIG Warranty Guard and underwritten by New Hampshire Insurance Company on behalf of DIRECTV where authorized by law. Certain limitations may apply. Pricing, terms and conditions of the DIRECTV PROTECTION PLAN are subject to change. Full terms and conditions will be mailed to you prior to service billing and are available at [directv.com/protection](http://directv.com/protection).

## FCC CUSTOMER INFORMATION

This device complies with Part 15 of the FCC Rules. Operation is subject to the following two conditions: (1) this device may not cause harmful interference, and (2) this device must accept any interference received, including interference that may cause undesired operation.

Responsible Party:

**DIRECTV**  
**2230 E. Imperial Hwy**  
**El Segundo, CA 90245**  
**1-800-DIRECTV**

- Trade Name: DIRECTV
- Type of Equipment: DIRECTV Satellite Receiver
- Model Numbers: D or H

Federal Communications Commission (FCC): This equipment complies with both Part 15 and Part 68 of the FCC rules.

This equipment has been tested and found to comply with the limits of a Class B digital device, pursuant to part 15 of the FCC Rules. These limits are designed to provide reasonable protection against harmful interference in a residential installation.

This equipment generates, uses, and can radiate radio frequency energy and, if not installed and used in accordance with the instructions, may cause harmful interference to radio communications. However there is no guarantee that interference will not occur in a particular installation. If this equipment does cause harmful interference to radio or television reception, which can be determined by removing and applying power to the equipment, the user is encouraged to try to correct the interference by one or more of the following measures:

- Reorient or relocate the receiving satellite dish antenna.
- Increase the separation between the equipment and the DIRECTV® Receiver.
- Connect the equipment into an outlet on a circuit different from that to which the DIRECTV® Receiver is connected.

- Consult the dealer or an experienced radio/TV technician for help.
- CAUTION: Changes or modifications not expressly approved by the manufacturer responsible for compliance could void the user's authority to operate the equipment.

The user may find the following booklet, prepared by the Federal communications Commission, helpful: "How to Identify and Resolve Radio and TV Interference Problems." This booklet is available from the U.S. Government Printing Office, Washington, DC. To meet FCC requirements, only peripherals (computer input/output devices, terminals, printers, etc.) certified to comply with Class B limits may be attached to this device. Operation with non-certified peripherals is likely to result in interference to radio and TV reception. To meet FCC requirements, shielded cables are required to connect the device to a personal computer, peripheral, or other Class B certified device.

This equipment complies with Part 68 of the FCC Rules and the requirements adopted by ACTA. On the back of this equipment is a label that contains a product identifier in the format US:AAAEQ##TXXXX.

If requested, this information must be provided to your telephone company. This equipment uses the following USOC Jack: RJ11C. A plug and jack used to connect this equipment to the premises' wiring and telephone network must comply with the applicable FCC Part 68 rules and requirements adopted by ACTA. A compliant telephone cord and modular plug is provided with this product. It is designed to be connected to a compatible modular jack that is also compliant.

See installation instructions for details.

The REN (Ringer Equivalence Number) is used to determine the number of devices that may connect to a telephone line. Excessive RENs on a telephone line may result in the devices not ringing in response to an incoming call. In most but not all areas, the sum of the RENs should not exceed five (5.0).

To be certain of the number of devices that may be connected to a line, as determined by the total RENs, contact your local telephone company. The REN for this product is part of the product identifier that has the format US: AA AEQ##TXXXX. The digits represented by ## are the REN without the decimal point (e.g., 03 is a REN of 0.3).

If this DIRECTV® Receiver causes harm to the telephone network, the telephone company will notify you in advance that temporary discontinuance of service may be required. But if advance notice isn't practical, the telephone company will notify the customer as soon as possible. Also, you will be advised of your right to file a complaint with the FCC if you believe it is necessary.

The telephone company may make changes in its facilities, equipment, operations or procedures that could affect the proper

## FCC CUSTOMER INFORMATION

functioning of your equipment. If they do, you will be notified in advance in order for you to make necessary modifications to maintain uninterrupted service. Connection to party line service is subject to state tariffs. Contact the state public utility commission, public service commission or corporation commission for information.

If trouble is experienced with this unit, for repair or warranty information, please contact DIRECTV Customer Care at the address and phone number listed below. If the equipment is causing harm to the network, the telephone company may request that you disconnect the equipment until the problem is resolved.

**DIRECTV**  
**2230 E. Imperial Hwy**  
**El Segundo, CA 90245**  
**1-800-DIRECTV**

If your home has specially wired alarm equipment connected to the telephone line, ensure the installation of this DIRECTV Satellite Receiver does not disable your alarm equipment. If you have questions about what will disable alarm equipment, consult your alarm company, telephone company or a qualified installer.

**DO NOT DISASSEMBLE THIS EQUIPMENT.** It does not contain any user-serviceable components.

We recommend the installation of an AC surge arrester in the AC outlet to which this equipment is connected. Telephone companies report that electrical surges, typically lightning transients, are very destructive to customer terminal equipment connected to AC power sources.

# TERMS AND CONDITIONS FOR USE OF SOFTWARE (“TERMS”)

THE DIRECTV® RECEIVER INCORPORATES SOFTWARE WHICH IS OWNED BY DIRECTV OR ITS THIRD PARTY LICENSORS (the “Software”). BEFORE USING THE RECEIVER, PLEASE READ THESE TERMS. IF YOU DO NOT AGREE TO THESE TERMS, YOU MAY NOT USE THE RECEIVER AND SHOULD IMMEDIATELY RETURN THE RECEIVER TO DIRECTV OR YOUR SUPPLIER. THESE TERMS ALSO APPLY TO ANY MODIFICATIONS, UPDATES OR SUPPLEMENTS TO THE SOFTWARE PROVIDED TO YOU.

## A. License Grant and Conditions

DIRECTV grants you a non-exclusive, non-transferable, limited license to use the Software solely in executable code form and solely as integrated with, incorporated into, and in conjunction with the Receiver. You must ensure that the copyright, trademark and other protective notices contained in the Software are maintained and not altered or removed. The Software is protected by copyright and other laws and international copyright and other treaties. All title and intellectual property rights in and to the Software and all modifications, updates, enhancements and derivative works of the Software are owned exclusively by DIRECTV or its licensors and you agree to execute any document reasonably requested by DIRECTV to evidence such ownership rights. Certain third party software used in connection with the Receiver may be made directly available to you by the providers thereof. The source code to certain software subject to the GNU GPL and other open source licenses that is used in connection with the Receiver is made available to you by DIRECTV following the written request to DIRECTV. Use of such Software is also subject to the terms of any applicable agreement between you and each such provider. DIRECTV reserves the right to modify, supplement, update and otherwise alter the Software via software download or other modification procedures, and these terms will apply to such Software as modified, supplemented, updated, and otherwise altered.

## B. License Restrictions

You may not copy, modify or transfer the Software, or any copy thereof, in whole or in part. You may not reverse engineer, disassemble, decompile or translate the Software, or otherwise attempt to derive the source code of the Software, except to the extent allowed under any applicable law. Any attempt to transfer any of the rights, duties or obligations of this license agreement is void. You may not rent, lease, load, resell for profit or distribute the Software, or any part thereof. You may not export, transfer or re-export the Software in violation of any applicable law. The Software may include some components that are covered by “free software” licenses, open source licenses and other similar license use rights, which require such components to be used, modified and/or distributed only under the terms of such licenses. Any such components are subject only to the terms of such licenses, and not these Terms.

# TERMS AND CONDITIONS FOR USE OF SOFTWARE (“TERMS”)

## C. Ownership of Software and Reservation of Rights

The Software is licensed, not sold, to you for use only under the terms of this license agreement, DIRECTV is NOT transferring title or any ownership rights in the Software to you and DIRECTV and its suppliers reserve all rights not expressly granted to you. Except as stated above, this license agreement does not grant to you any intellectual property rights in the Software.

## D. Termination

These Terms are effective until terminated. You may terminate these Terms by returning the Receiver to DIRECTV or your supplier. These Terms will terminate automatically without notice if you fail to comply with these Terms or any other agreement between you and DIRECTV. Upon termination you must return the Receiver to DIRECTV or your supplier.

## E. Disclaimer

THE SOFTWARE IS (TO THE EXTENT PERMITTED BY LAW) SUPPLIED “AS IS.” NEITHER DIRECTV NOR ANY OF ITS LICENSORS EXPRESSLY MAKES OR PASSES ON TO YOU ANY WARRANTY OR REPRESENTATION ON BEHALF OF DIRECTV OR ITS LICENSORS WITH RESPECT TO THE SOFTWARE, INCLUDING BUT NOT LIMITED TO ANY WARRANTIES, EXPRESS OR IMPLIED, INCLUDING (BUT NOT LIMITED TO) ANY IMPLIED WARRANTIES OF MERCHANTABILITY, SATISFACTORY QUALITY, FITNESS FOR A PARTICULAR PURPOSE, TITLE OR NON-INFRINGEMENT OF THIRD PARTY RIGHTS.

IN NO EVENT WILL DIRECTV OR ITS LICENSORS BE LIABLE TO YOU WITH RESPECT TO THE SOFTWARE FOR ANY DIRECT, INDIRECT, CONSEQUENTIAL, SPECIAL, PUNITIVE OR INCIDENTAL DAMAGE (INCLUDING LOSS OF PROFITS, LOST SAVINGS, LOSS OF DATA OR THE COST OF PROCUREMENT OF SUBSTITUTE GOODS, TECHNOLOGY OR SERVICES) ARISING OUT OF THE USE OR THE INABILITY TO USE THE SOFTWARE, EVEN IF DIRECTV OR ITS LICENSORS HAVE BEEN ADVISED OF THE POSSIBILITY OF SUCH DAMAGES, OR FOR ANY CLAIM BY A THIRD PARTY. Some states or jurisdictions do not allow the exclusion or limitation of incidental, consequential or special damages, so the above limitations may not apply to you.

## F. Third Party Beneficiaries

DIRECTV’S LICENSORS AND SUPPLIERS SHALL BE THIRD PARTY BENEFICIARIES OF THESE LICENSE TERMS, AS APPLICABLE. YOUR USE OF THE RECEIVER CONSTITUTES YOUR ACKNOWLEDGEMENT THAT YOU HAVE READ THESE TERMS AND AGREE TO BE BOUND HEREBY.

# TERMS AND CONDITIONS FOR USE OF SOFTWARE (“TERMS”)

## G. Additional Information

Certain additional terms and information for the Software and certain third party software (including the text of licenses applicable to any free, open source and other similar software that may be included in the Software) may be found in the DIRECTV website located at [www.directv.com](http://www.directv.com), and the GNU website located at [www.gnu.org](http://www.gnu.org).

## H. GNU GPL and Open Source Software

Certain components of the Software may be subject to the GNU General Public Licence, Version 2, June 1991 (“GPL”), “free software” licenses and other open source software licenses. The foregoing components of the Software are not and may not be subject to the License Restrictions in Section B above. In compliance with the GPL, DIRECTV, its suppliers, or its third party licensors, upon written request, will make the source code of the software, libraries and associated utilities it uses, together with its modifications (if any), available to the public in source code form. You are free to use, modify and distribute the software and any modifications as long as you comply with the terms of the GPL referred to above and other open source software licenses. The license terms applicable to the GPL may be found in the DIRECTV website located at [www.directv.com](http://www.directv.com), and the GNU website located at [www.gnu.org](http://www.gnu.org), specifically at [<http://www.gnu.org/licenses/old-licenses/gpl-2.0.html>]. To request a copy of the applicable source code please write to DIRECTV at:

**Attention: Vice President, STB Engineering**  
**DIRECTV**  
**2230 E. Imperial Highway**  
**El Segundo, CA 90245**

## GNU GENERAL PUBLIC LICENSE

Version 2, June 1991

Copyright © 1989, 1991 Free Software Foundation, Inc.,  
51 Franklin Street, Fifth Floor, Boston, MA 02110-1301 USA  
Everyone is permitted to copy and distribute verbatim copies  
of this license document, but changing it is not allowed.

# TERMS AND CONDITIONS FOR USE OF SOFTWARE (“TERMS”)

## Preamble

The licenses for most software are designed to take away your freedom to share and change it. By contrast, the GNU General Public License is intended to guarantee your freedom to share and change free software--to make sure the software is free for all its users. This General Public License applies to most of the Free Software Foundation's software and to any other program whose authors commit to using it. (Some other Free Software Foundation software is covered by the GNU Lesser General Public License instead.) You can apply it to your programs, too.

When we speak of free software, we are referring to freedom, not price. Our General Public Licenses are designed to make sure that you have the freedom to distribute copies of free software (and charge for this service if you wish), that you receive source code or can get it if you want it, that you can change the software or use pieces of it in new free programs; and that you know you can do these things.

To protect your rights, we need to make restrictions that forbid anyone to deny you these rights or to ask you to surrender the rights. These restrictions translate to certain responsibilities for you if you distribute copies of the software, or if you modify it.

For example, if you distribute copies of such a program, whether gratis or for a fee, you must give the recipients all the rights that you have. You must make sure that they, too, receive or can get the source code. And you must show them these terms so they know their rights.

We protect your rights with two steps: (1) copyright the software, and (2) offer you this license which gives you legal permission to copy, distribute and/or modify the software.

Also, for each author's protection and ours, we want to make certain that everyone understands that there is no warranty for this free software. If the software is modified by someone else and passed on, we want its recipients to know that what they have is not the original, so that any problems introduced by others will not reflect on the original authors' reputations.

Finally, any free program is threatened constantly by software patents. We wish to avoid the danger that redistributors of a free program will individually obtain patent licenses, in effect making the program proprietary. To prevent this, we have made it clear that any patent must be licensed for everyone's free use or not licensed at all.

The precise terms and conditions for copying, distribution and modification follow.



# TERMS AND CONDITIONS FOR USE OF SOFTWARE (“TERMS”)

## GNU GENERAL PUBLIC LICENSE

### TERMS AND CONDITIONS FOR COPYING, DISTRIBUTION AND MODIFICATION

0. This License applies to any program or other work which contains a notice placed by the copyright holder saying it may be distributed under the terms of this General Public License. The “Program”, below, refers to any such program or work, and a “work based on the Program” means either the Program or any derivative work under copyright law: that is to say, a work containing the Program or a portion of it, either verbatim or with modifications and/or translated into another language. (Hereinafter, translation is included without limitation in the term “modification”.) Each licensee is addressed as “you”.

Activities other than copying, distribution and modification are not covered by this License; they are outside its scope. The act of running the Program is not restricted, and the output from the Program is covered only if its contents constitute a work based on the Program (independent of having been made by running the Program). Whether that is true depends on what the Program does.

1. You may copy and distribute verbatim copies of the Program’s source code as you receive it, in any medium, provided that you conspicuously and appropriately publish on each copy an appropriate copyright notice and disclaimer of warranty; keep intact all the notices that refer to this License and to the absence of any warranty; and give any other recipients of the Program a copy of this License along with the Program.

You may charge a fee for the physical act of transferring a copy, and you may at your option offer warranty protection in exchange for a fee.

2. You may modify your copy or copies of the Program or any portion of it, thus forming a work based on the Program, and copy and distribute such modifications or work under the terms of Section 1 above, provided that you also meet all of these conditions:

- a) You must cause the modified files to carry prominent notices stating that you changed the files and the date of any change.
- b) You must cause any work that you distribute or publish, that in whole or in part contains or is derived from the Program or any part thereof, to be licensed as a whole at no charge to all third parties under the terms of this License.
- c) If the modified program normally reads commands interactively when run, you must cause it, when started running for such interactive use in the most ordinary way, to print or display an announcement including an appropriate copyright notice and a notice that there is no warranty (or else, saying that you provide a warranty) and that users may redistribute the program under these conditions, and telling the user how to view a copy of this License. (Exception: if the Program itself is interactive but does not normally print such an announcement, your work based on the Program is not required to print an announcement.)

These requirements apply to the modified work as a whole. If identifiable sections of that work are not derived from the Program,

## TERMS AND CONDITIONS FOR USE OF SOFTWARE (“TERMS”)

and can be reasonably considered independent and separate works in themselves, then this License, and its terms, do not apply to those sections when you distribute them as separate works. But when you distribute the same sections as part of a whole which is a work based on the Program, the distribution of the whole must be on the terms of this License, whose permissions for other licensees extend to the entire whole, and thus to each and every part regardless of who wrote it.

Thus, it is not the intent of this section to claim rights or contest your rights to work written entirely by you; rather, the intent is to exercise the right to control the distribution of derivative or collective works based on the Program.

In addition, mere aggregation of another work not based on the Program with the Program (or with a work based on the Program) on a volume of a storage or distribution medium does not bring the other work under the scope of this License.

3. You may copy and distribute the Program (or a work based on it, under Section 2) in object code or executable form under the terms of Sections 1 and 2 above provided that you also do one of the following:

- a) Accompany it with the complete corresponding machine-readable source code, which must be distributed under the terms of Sections 1 and 2 above on a medium customarily used for software interchange; or,
- b) Accompany it with a written offer, valid for at least three years, to give any third party, for a charge no more than your cost of physically performing source distribution, a complete machine-readable copy of the corresponding source code, to be distributed under the terms of Sections 1 and 2 above on a medium customarily used for software interchange; or,
- c) Accompany it with the information you received as to the offer to distribute corresponding source code. (This alternative is allowed only for noncommercial distribution and only if you received the program in object code or executable form with such an offer, in accord with Subsection b above.)

The source code for a work means the preferred form of the work for making modifications to it. For an executable work, complete source code means all the source code for all modules it contains, plus any associated interface definition files, plus the scripts used to control compilation and installation of the executable. However, as a special exception, the source code distributed need not include anything that is normally distributed (in either source or binary form) with the major components (compiler, kernel, and so on) of the operating system on which the executable runs, unless that component itself accompanies the executable.

If distribution of executable or object code is made by offering access to copy from a designated place, then offering equivalent access to copy the source code from the same place counts as distribution of the source code, even though third parties are not

# TERMS AND CONDITIONS FOR USE OF SOFTWARE (“TERMS”)

compelled to copy the source along with the object code.

4. You may not copy, modify, sublicense, or distribute the Program except as expressly provided under this License. Any attempt otherwise to copy, modify, sublicense or distribute the Program is void, and will automatically terminate your rights under this License.

However, parties who have received copies, or rights, from you under this License will not have their licenses terminated so long as such parties remain in full compliance.

5. You are not required to accept this License, since you have not signed it. However, nothing else grants you permission to modify or distribute the Program or its derivative works. These actions are prohibited by law if you do not accept this License. Therefore, by modifying or distributing the Program (or any work based on the Program), you indicate your acceptance of this License to do so, and all its terms and conditions for copying, distributing or modifying the Program or works based on it.

6. Each time you redistribute the Program (or any work based on the Program), the recipient automatically receives a license from the original licensor to copy, distribute or modify the Program subject to these terms and conditions. You may not impose any further restrictions on the recipients' exercise of the rights granted herein. You are not responsible for enforcing compliance by third parties to this License.

7. If, as a consequence of a court judgment or allegation of patent infringement or for any other reason (not limited to patent issues), conditions are imposed on you (whether by court order, agreement or otherwise) that contradict the conditions of this License, they do not excuse you from the conditions of this License. If you cannot distribute so as to satisfy simultaneously your obligations under this License and any other pertinent obligations, then as a consequence you may not distribute the Program at all. For example, if a patent license would not permit royalty-free redistribution of the Program by all those who receive copies directly or indirectly through you, then the only way you could satisfy both it and this License would be to refrain entirely from distribution of the Program.

If any portion of this section is held invalid or unenforceable under any particular circumstance, the balance of the section is intended to apply and the section as a whole is intended to apply in other circumstances.

It is not the purpose of this section to induce you to infringe any patents or other property right claims or to contest validity of any such claims; this section has the sole purpose of protecting the integrity of the free software distribution system, which is implemented by public license practices. Many people have made generous contributions to the wide range of software

## TERMS AND CONDITIONS FOR USE OF SOFTWARE (“TERMS”)

distributed through that system in reliance on consistent application of that system; it is up to the author/donor to decide if he or she is willing to distribute software through any other system and a licensee cannot impose that choice.

This section is intended to make thoroughly clear what is believed to be a consequence of the rest of this License.

8. If the distribution and/or use of the Program is restricted in certain countries either by patents or by copyrighted interfaces, the original copyright holder who places the Program under this License may add an explicit geographical distribution limitation excluding those countries, so that distribution is permitted only in or among countries not thus excluded. In such case, this License incorporates the limitation as if written in the body of this License.

9. The Free Software Foundation may publish revised and/or new versions of the General Public License from time to time. Such new versions will be similar in spirit to the present version, but may differ in detail to address new problems or concerns. Each version is given a distinguishing version number. If the Program specifies a version number of this License which applies to it and “any later version”, you have the option of following the terms and conditions either of that version or of any later version published by the Free Software Foundation. If the Program does not specify a version number of this License, you may choose any version ever published by the Free Software Foundation.

10. If you wish to incorporate parts of the Program into other free programs whose distribution conditions are different, write to the author to ask for permission. For software which is copyrighted by the Free Software Foundation, write to the Free Software Foundation; we sometimes make exceptions for this. Our decision will be guided by the two goals of preserving the free status of all derivatives of our free software and of promoting the sharing and reuse of software generally.

### NO WARRANTY

11. BECAUSE THE PROGRAM IS LICENSED FREE OF CHARGE, THERE IS NO WARRANTY FOR THE PROGRAM, TO THE EXTENT PERMITTED BY APPLICABLE LAW. EXCEPT WHEN OTHERWISE STATED IN WRITING THE COPYRIGHT HOLDERS AND/OR OTHER PARTIES PROVIDE THE PROGRAM “AS IS” WITHOUT WARRANTY OF ANY KIND, EITHER EXPRESSED OR IMPLIED, INCLUDING, BUT NOT LIMITED TO, THE IMPLIED WARRANTIES OF MERCHANTABILITY AND FITNESS FOR A PARTICULAR PURPOSE. THE ENTIRE RISK AS TO THE QUALITY AND PERFORMANCE OF THE PROGRAM IS WITH YOU. SHOULD THE PROGRAM PROVE DEFECTIVE, YOU ASSUME THE COST OF ALL NECESSARY SERVICING, REPAIR OR CORRECTION.

12. IN NO EVENT UNLESS REQUIRED BY APPLICABLE LAW OR AGREED TO IN WRITING WILL ANY COPYRIGHT HOLDER, OR ANY OTHER PARTY WHO MAY MODIFY AND/OR REDISTRIBUTE THE PROGRAM AS PERMITTED ABOVE, BE LIABLE TO YOU FOR

# TERMS AND CONDITIONS FOR USE OF SOFTWARE (“TERMS”)

DAMAGES, INCLUDING ANY GENERAL, SPECIAL, INCIDENTAL OR CONSEQUENTIAL DAMAGES ARISING OUT OF THE USE OR INABILITY TO USE THE PROGRAM (INCLUDING BUT NOT LIMITED TO LOSS OF DATA OR DATA BEING RENDERED INACCURATE OR LOSSES SUSTAINED BY YOU OR THIRD PARTIES OR A FAILURE OF THE PROGRAM TO OPERATE WITH ANY OTHER PROGRAMS), EVEN IF SUCH HOLDER OR OTHER PARTY HAS BEEN ADVISED OF THE POSSIBILITY OF SUCH DAMAGES.

END OF TERMS AND CONDITIONS

How to Apply These Terms to Your New Programs

If you develop a new program, and you want it to be of the greatest possible use to the public, the best way to achieve this is to make it free software which everyone can redistribute and change under these terms.

To do so, attach the following notices to the program. It is safest to attach them to the start of each source file to most effectively convey the exclusion of warranty; and each file should have at least the “copyright” line and a pointer to where the full notice is found.

<one line to give the program’s name and a brief idea of what it does.>

Copyright (C) <year> <name of author>

This program is free software; you can redistribute it and/or modify it under the terms of the GNU General Public License as published by the Free Software Foundation; either version 2 of the License, or (at your option) any later version.

This program is distributed in the hope that it will be useful, but WITHOUT ANY WARRANTY; without even the implied warranty of MERCHANTABILITY or FITNESS FOR A PARTICULAR PURPOSE. See the GNU General Public License for more details. You should have received a copy of the GNU General Public License along with this program; if not, write to the Free Software Foundation, Inc., 51 Franklin Street, Fifth Floor, Boston, MA 02110-1301 USA.

Also add information on how to contact you by electronic and paper mail. If the program is interactive, make it output a short notice like this when it starts in an interactive mode:

Gnomovision version 69, Copyright (C) year name of author

Gnomovision comes with ABSOLUTELY NO WARRANTY; for details type `show w`. This is free software, and you are welcome to redistribute it under certain conditions; type `show c` for details.

The hypothetical commands `show w` and `show c` should show the appropriate parts of the General Public License. Of course, the commands you use may be called something other than `show w` and `show c`; they could even be mouse-clicks or menu items--whatever suits your program.

## TERMS AND CONDITIONS FOR USE OF SOFTWARE (“TERMS”)

You should also get your employer (if you work as a programmer) or your school, if any, to sign a “copyright disclaimer” for the program, if necessary. Here is a sample; alter the names:

Yoyodyne, Inc., hereby disclaims all copyright interest in the program `Gnomovision' (which makes passes at compilers) written by James Hacker.

<signature of Ty Coon>, 1 April 1989

Ty Coon, President of Vice

This General Public License does not permit incorporating your program into proprietary programs. If your program is a subroutine library, you may consider it more useful to permit linking proprietary applications with the library. If this is what you want to do, use the GNU Lesser General Public License instead of this License.

## APPENDICES

---

<b>Appendix 1: Setup and Activation</b> .....	<b>88</b>
Guided Setup .....	88
Active Your DIRECTV® Service .....	88
<b>Appendix 2: Connections to TV and Equipment</b> .....	<b>89</b>
Your Phone Connection .....	89
Your Internet Connection .....	89
Connections for Auxiliary Equipment .....	90
<b>Appendix 3: Receivers Front and Back Panels</b> .....	<b>95</b>
<b>Appendix 4: How to Network Your HD Receiver</b> .....	<b>99</b>
Professionally Installed DIRECTV CINEMA Connection Kit ...	100
Self-Installed DIRECTV CINEMA Connection Kit - Wireless	101
Wired .....	101
Wireless .....	103
<b>Appendix 5: About High-Definition</b> .....	<b>106</b>
Screen Format & Resolution.....	106
Supported Resolutions .....	107
Wide-Screen vs. Standard Formats .....	108

# APPENDIX 1: SETUP AND ACTIVATION

## GUIDED SETUP

If your receiver was not professionally installed, or you have had to reset your receiver for any reason, you will need to follow the guided setup screens before starting DIRECTV service.

1. Make sure the MODE switch at the top of the remote control is set to DIRECTV, which is the far-left position.
2. Press PWR. The DIRECTV® Receiver will turn on. (Make sure your TV is also turned on!)
3. The first screen will allow you to select a language. Using the arrow keys on the remote control, move to the language you prefer and press SELECT.
4. Follow the onscreen instructions.

After these setup procedures are complete, you'll see a message onscreen that says, "Acquiring Satellite Info". Your receiver is gathering information from the satellite for the onscreen program guide. Next you'll be asked if you want to program your remote to control other equipment such as your TV and/or DVR player.

## ACTIVATE YOUR DIRECTV® SERVICE

Once all the setup processes are complete, all that's left to do is activate your DIRECTV® service. Be sure to:

1. Have on hand your service address, social security number and a valid major credit card.
2. Note your receiver ID and access card numbers. The receiver ID is on a sticker behind the access card door on the front of the receiver, while the card number is on the access card itself. Use the Product Information page to note this information.
3. When you're ready, just call 1-800-531-5000 to pick the programming package that's right for you and subscribe to DIRECTV service.



### YOUR PHONE CONNECTION

Connecting your receiver to a land-based telephone line saves you money because it allows you to purchase Pay Per View movies and special events without calling DIRECTV to order. It is required for sports package subscriptions and is also used to enhance the interactive features available on our interactive channels. The receiver uses a toll-free number once a month for a few minutes duration and is designed not to interfere with your regular phone service. You will need an RJ11-type modulator jack (the most common type of phone jack). If you disconnect the phone line, the receiver will not allow you to purchase PPV programs and some features of our interactive channels will be limited. If your receiver is connected to the Internet, either directly or via a DIRECTV Home Network connection, you do not need to be connected to a phone line. See “Your Internet Connection” below.

**Do not connect your receiver to a digital PBX phone system — doing so may permanently damage your equipment and void your warranty.**

### YOUR INTERNET CONNECTION

Connecting your DIRECTV Receiver to the Internet and your home network gives you access to features like TV Apps, Music & Photos, and more.

The instructions for connecting to a network are different depending upon whether you have Whole-Home DVR Service. Please see Appendix 4.

**NOTE:** For the most current options and instructions to connect your receiver to the Internet, please visit [directv.com/getconnected](http://directv.com/getconnected).

## APPENDIX 2: CONNECTIONS TO TV AND EQUIPMENT

### CONNECTIONS FOR AUXILIARY EQUIPMENT

If you upgrade your TV, get a new DIRECTV Receiver, or add new equipment such as a surround sound system, DVD player or burner, or VCR, you have various options for connecting your equipment. All of the video and audio outputs on your receiver offer good quality. Pick a video and audio output from the following lists based on the connectors your receiver and TV support; they are listed in order, with the highest quality options at the top of each list. Not all connectors are available on all receivers and TV models.

#### NOTE:

- Not all cables come with your digital satellite receiver; you may need to purchase additional cables depending on your setup.
- Never connect an IN to an IN or an OUT to an OUT. All A/V jacks and inputs are color-coded. Always match the color of the plug to the same color of the jack.
- To obtain the best picture quality, make sure the receiver is connected directly to the TV.
- Due to restrictions imposed by copyright holders, certain programming may include content protection measures that may restrict viewing or recording with certain consumer electronics equipment attached to the receiver. Please contact the manufacturer of such equipment for additional information.

**WARNING:** Do not connect your receiver (or any other equipment, such as a TV or VCR) to the AC power supply until you have properly connected all the other cables.

#### Video Connections

- **HDMI [High-Definition Multimedia Interface]** provides the best digital video and digital audio in one connector.
- **Component Video Output [YPbPr]** provides high-quality video, but does not provide audio. You will need to connect audio separately using the digital audio or RCA audio connectors. Newer receivers (model H25) have an "A/V Out" connector that provides Component Video and RCA audio output in a single, custom cable.
- **S-Video** provides good video, but does not provide audio. You will need to connect audio separately using the digital audio or RCA audio connectors. (Not all receivers have S-Video outputs.)

## APPENDIX 2: CONNECTIONS TO TV AND EQUIPMENT

- **RCA output (composite video)** provides good video and usually comes bundled with three cables for one video and two audio channels.

### Audio Connections

- **HDMI [High-Definition Multimedia Interface]** provides the best digital video and audio in one connector.
- **Digital Audio Optical** provides excellent quality digital audio and is often used on newer surround sound and DVD equipment.
- **Digital Audio Coax** provides high quality digital audio and is also found on newer surround sound and DVD equipment.
- **RCA** outputs provide good audio quality and are found on older auxiliary equipment.

There are so many makes and models of TVs and auxiliary equipment, it is impossible to fully describe all of the possible connections between them and your receiver. Refer to the manuals for that equipment to see the connection options specific to each make and model. The following images show examples of how your receiver may be connected, using the supported video and audio connections for the TV, the surround sound, and the DVD player/burner or VCR. Several models of DIRECTV Receivers are shown, giving you a variety of connection options to your TV and other equipment.

### Example: TV with HDMI Connector

Here is an example using a TV that has an HDMI connector as the best video/audio input and a surround sound system that has a digital audio optical connector as the best audio input, connecting to a DIRECTV HD Receiver.

This example also shows using a DVD burner with RCA audio and component video connectors.

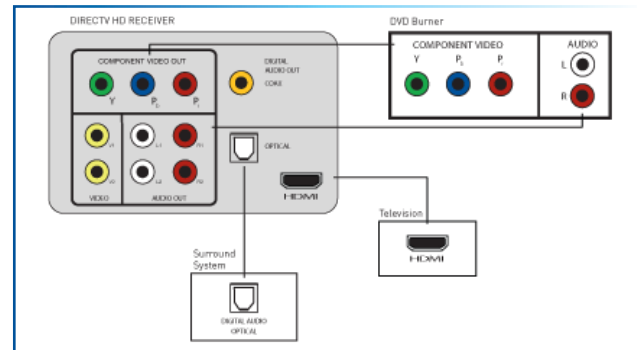

## APPENDIX 2: CONNECTIONS TO TV AND EQUIPMENT

### Example: TV with Component Video Connectors

Here is an example using a TV that has component video connectors as the best video input with RCA audio connectors as the best audio input and a surround sound system that has a digital audio coax connector as the best audio input.

This example also shows using a VCR with RCA audio and video connectors.

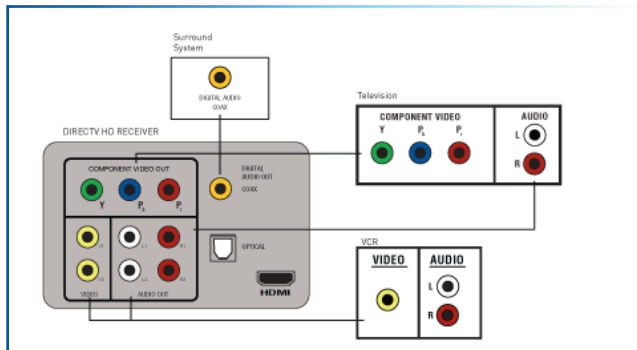

### Example: TV with S-Video Connector

Here is an example of a TV that has an S-Video connector as the best video input and RCA audio connectors as the best audio input and a surround sound system with a digital audio optical connector as the best audio input. (Not all receivers have an S-Video connector.)

This example also shows using a DVD burner with component video connectors and RCA audio connectors.

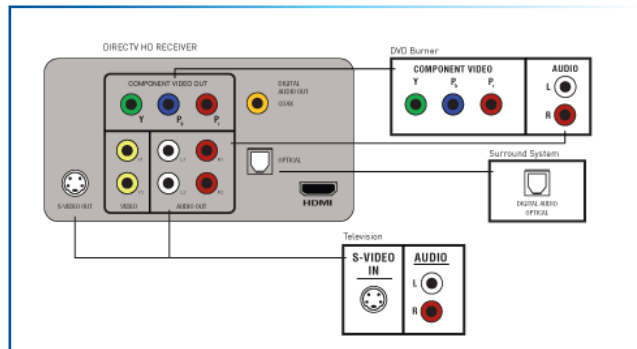

## APPENDIX 2: CONNECTIONS TO TV AND EQUIPMENT

### Example: TV with RCA Connectors

Here is an example of a TV that has RCA connectors as the best video input and RCA audio connectors as the best audio input.

This example also shows using a VCR with component video connectors and RCA audio connectors.

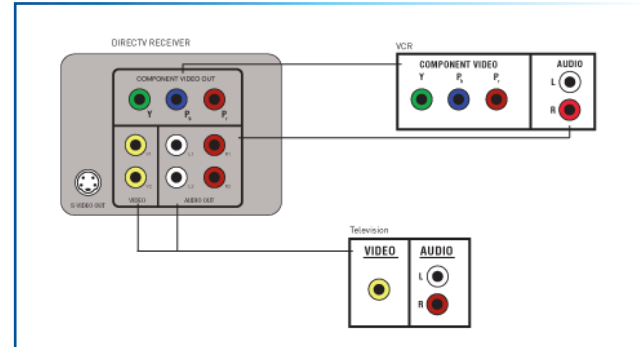

### Receiver with A/V Out Connector

Some HD receivers have a special A/V Out connector that supports either component or RCA (composite) video. Receiver model H25 comes with the A/V Out cable that supports component video and RCA audio. You can also purchase an optional cable with A/V Out to RCA audio and video (composite) connectors.

### Example: Using the A/V Out Component Video Cable

Here is an example using a TV that has an HDMI connector as the best audio/video input.

This example also shows connecting your receiver to a DVD burner using the AV Out cable that comes with your receiver for component video and RCA audio connections.

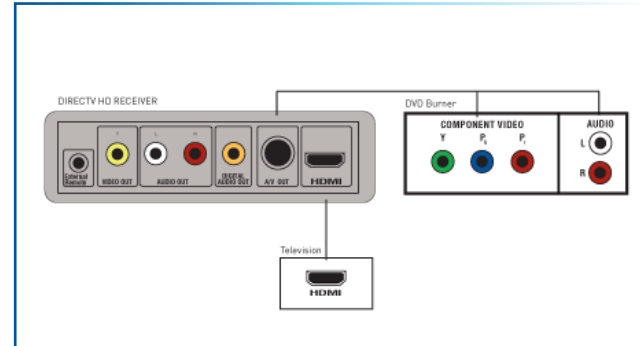

## APPENDIX 2: CONNECTIONS TO TV AND EQUIPMENT

### Example: Using the A/V Out RCA Video (Composite) Cable

Here is an example using a TV that has an HDMI connector as the best audio/video input.

This example also shows using a DVD burner using the optional A/V Out cable with RCA video and audio connectors, and a VCR using RCA video and audio connectors.

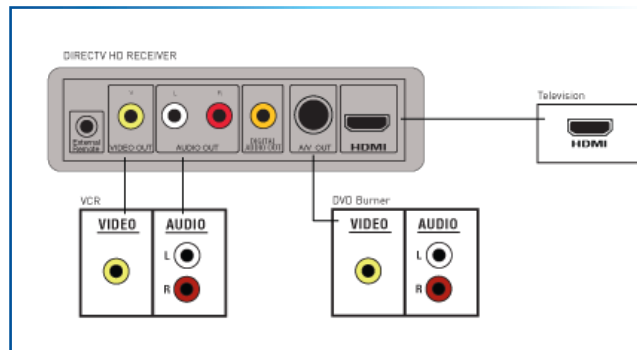

# APPENDIX 3: RECEIVERS FRONT AND BACK PANELS

## HIGH-DEFINITION RECEIVER

### Front Panel Examples

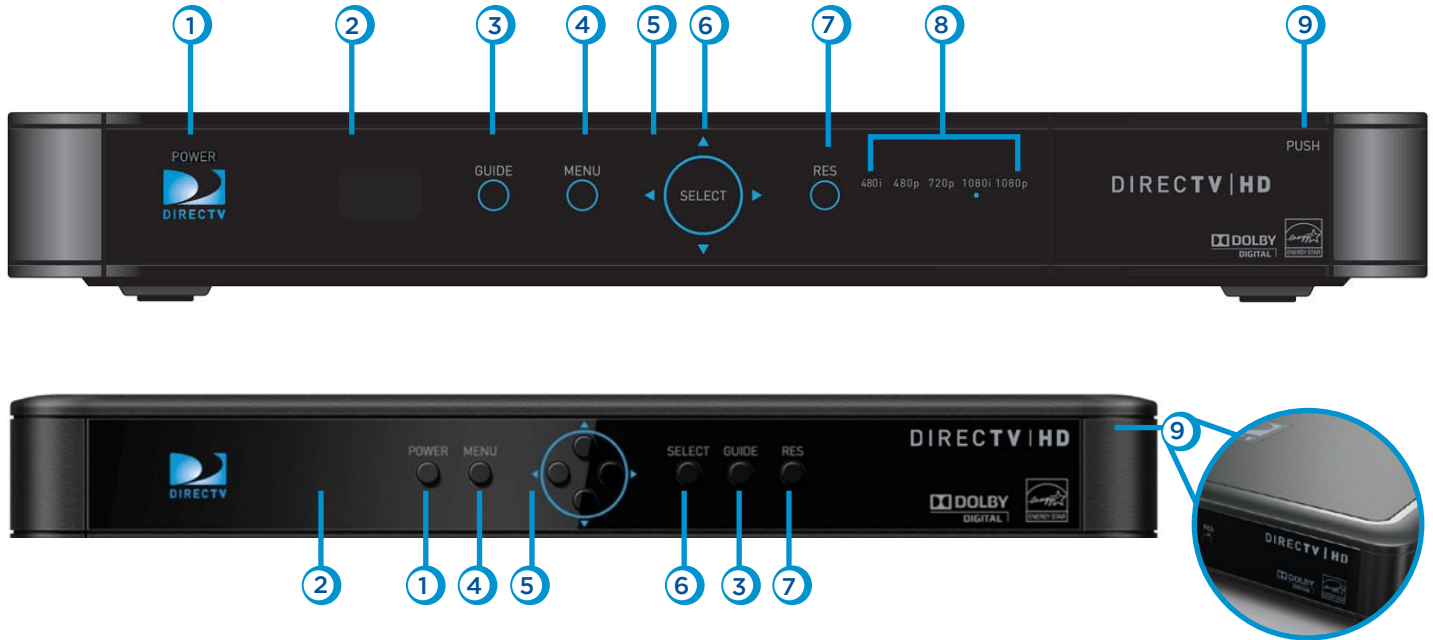

*Your equipment may not look exactly like the model illustrated.*

## APPENDIX 3: RECEIVERS FRONT AND BACK PANELS

1. **POWER** – Turns your DIRECTV® Receiver on or off. Your receiver still tunes and receives messages when powered off. The power light flashes when you press a key on the remote to let you know it has received the command.
2. **REMOTE SENSOR** – The infrared sensor picks up commands from the remote control. You cannot have any opaque object between the remote and this sensor or else the command will not get through. If you have an optional RF remote, this sensor is not used. With an optional RF remote you can place your receiver inside a cabinet or any nonmetal enclosure and it will receive the remote control commands up to 200 feet away.
3. **GUIDE** – Displays the onscreen program guide.
4. **MENU** - Brings up the main menu to access settings and services.
5. **ARROWS** – Move the onscreen highlight up, down, left or right.
6. **SELECT** – Selects the item highlighted.
7. **RES (Resolution)** – The RES key switches the output resolution of the HD Receiver. Each time you press the key, it cycles to the next available resolution: 1080p, 1080i, 720p, 480p and 480i (older models may not support 1080p).

**NOTE:** The RES button on the front panel only changes the resolution. It does not change the screen format (crop, stretch, letterbox, pillar box). The FORMAT button on the remote control cycles through all of the screen formats and resolutions. See Appendix 3 for details.

8. **RESOLUTION INDICATORS** – The adjacent lights indicate the current resolution setting. Some receivers do not have these indicators.
9. **DOOR PANEL** – The access card slot, RESET button, receiver ID and model number are located behind the door panel. Some receivers have the RESET button on the side panel, with no door, and the receiver ID on a sticker underneath the unit.

**Older models may have these additional buttons on the front panel:**

**ACTIVE** - Displays the DIRECTV Active Channel - local weather and more.

**INFO** - Displays the channel banner or program information.



## HIGH-DEFINITION RECEIVER

### Back Panel Examples

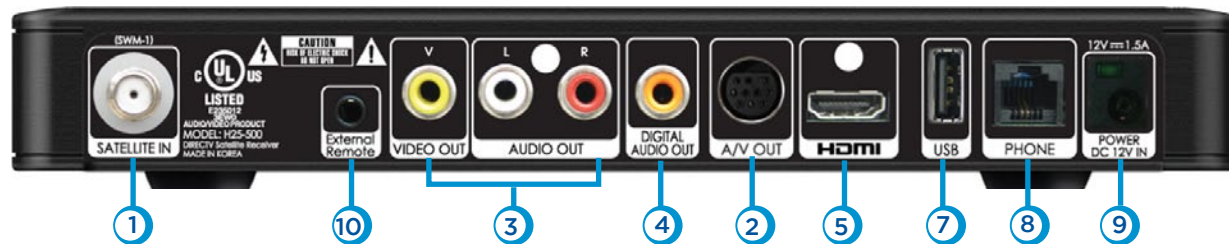
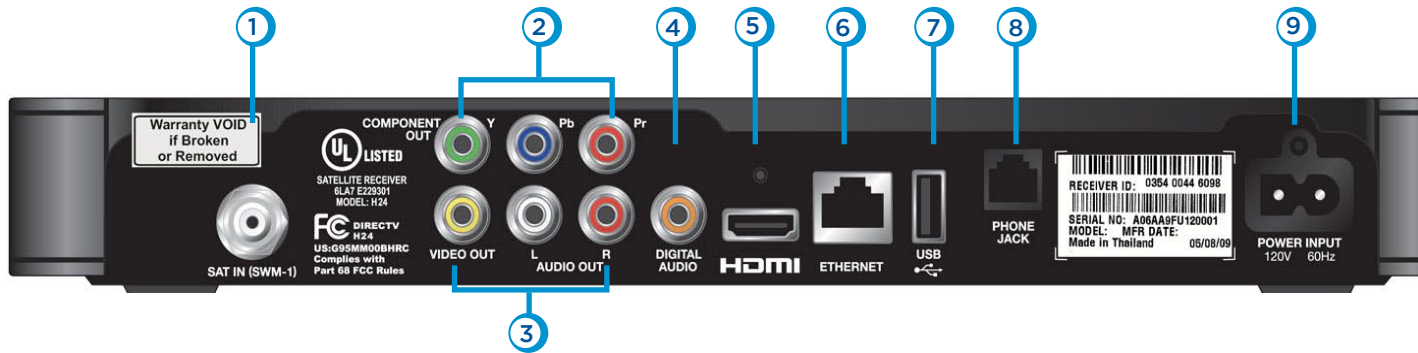

Your equipment may not look exactly like the model illustrated.

## APPENDIX 3: RECEIVERS FRONT AND BACK PANELS

1. **SATELLITE IN (SWM-1)** – Connect one line from your satellite dish here. A Single Wire Multi-Switch (SWM) connection, if applicable, is made to this satellite in port.
2. **COMPONENT VIDEO OUT**– Some receivers have a block of three separate connectors - green, red, blue. Use this block to connect up HD component video cables and use the white and red RCA connectors below it for analog audio out.  
**A/V OUT** - Some newer model receivers have a combined 10-pin output that supports both audio and video. Receivers supporting A/V Out come with an A/V Out cable for Component Video and RCA audio. An A/V Out cable for Composite Video and RCA audio can be purchased separately.
3. **RCA-Audio/Video Jacks** – A Standard-Definition (SD) output. You can use the entire row of RCA connectors (yellow, white and red) to feed a VCR or DVD player/burner.
4. **DIGITAL AUDIO OUT** – Use this digital audio connection for sound. Not available on all models.
5. **HDMI** – Use this combination digital video and audio connector for the best HD picture quality.
6. **ETHERNET** – For future use. Not available on all models.
7. **USB** – For future use. (USB 2.0 Host 5V = 500mA)
8. **PHONE JACK** – Connect your phone line here to enable Pay Per View purchasing and Caller ID (if your phone service package includes it).
9. **POWER** – Your receiver must be plugged in at all times to function properly. Note that some newer model receivers require an external power supply, while older models plug in through a direct power cord.
10. **EXTERNAL REMOTE** – Some model receivers support an external adapter for use with an optional RF remote. Other models have RF built-in.

## APPENDIX 4: HOW TO NETWORK YOUR HD RECEIVER

To use your DIRECTV HD Receiver on your home network, you will need:

- A compatible DIRECTV Receiver, such as the DIRECTV HD Receiver (models H21 or later), DIRECTV Plus® HD DVR Receiver (models HR20 or later) or DIRECTV Plus® DVR (model R22). Model H25 can only be connected using Whole-Home DVR service.
- A broadband Internet connection, with a minimum connection speed of 750 kbps or higher (DSL or cable).
- A network router with an available Ethernet port, and/or wireless capability.

**NOTE:** For the most current options and instructions to connect your receiver to the Internet, please visit [directv.com/getconnected](http://directv.com/getconnected).

The instructions for connecting to a network are different depending upon whether you have Whole-Home DVR Service. Please see the appropriate sections that follow.

### If you have Whole-Home DVR service:

- Professionally Installed DIRECTV CINEMA Connection Kit: Schedule a professional installation appointment at [directv.com/getconnected](http://directv.com/getconnected).
- Wireless Self-Installed DIRECTV Cinema Connection Kit: If you already connect to the Internet via WiFi, you can order this wireless kit at [directv.com](http://directv.com) and connect yourself.

### If you do not have Whole-Home DVR service:

- **Wired:** The fastest, most reliable connection. Your house must be wired for Ethernet, or you must run cables from a network router to your DIRECTV HD Receiver.
- **Wireless:** This can be easiest method if you already connect to the Internet via Wi-Fi. However, wireless connections may be slower and somewhat less reliable than wired. You can order the Wireless DIRECTV CINEMA Connection Kit from [directv.com](http://directv.com), or at 1-800-531-5000.

## APPENDIX 4: HOW TO NETWORK YOUR HD RECEIVER

If you have Whole-Home DVR Service:

### PROFESSIONALLY INSTALLED DIRECTV CINEMA CONNECTION KIT

Because Whole-Home DVR service uses a network to share programs between your DIRECTV receivers, only a professionally installed DIRECTV CINEMA Connection Kit or the DIRECTV CINEMA Connection Kit - Wireless can be used to connect to the Internet.

- Never connect an Ethernet cable to an HR24 or H24 receiver with Whole-Home DVR service; this will disable the Whole-Home network and disable playlist sharing.
- If you have DECA Connected Home Adapters connected to your HD DVR (Models HR20-23, R22), you must use either a professionally installed DIRECTV CINEMA Connection Kit, or the DIRECTV CINEMA Connection Kit - Wireless, to connect to the Internet.

Your professionally installed DIRECTV CINEMA Connection Kit will include a Broadband DECA similar to one shown of the models here.

The DIRECTV CINEMA Connection Kit connects to a coaxial cable and an Ethernet cable connected to your home router to provide home network and Internet connectivity to all of the Whole-Home capable receivers in your household.

If you have Whole-Home DVR Service and are having difficulty accessing the DIRECTV CINEMA service or DIRECTV™ Media Share features, check to ensure the Broadband DECA is powered and the coaxial cable and Ethernet cable are firmly connected.

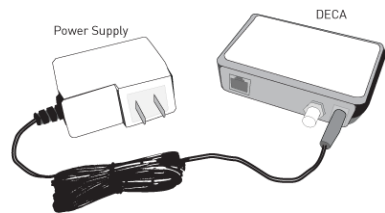
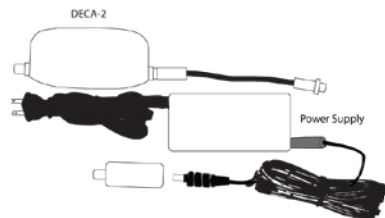

## APPENDIX 4: HOW TO NETWORK YOUR HD RECEIVER

### SELF-INSTALLED DIRECTV CINEMA CONNECTION KIT - WIRELESS

You can also order the DIRECTV CINEMA Connection Kit - Wireless from [directv.com](http://directv.com), or by calling 1-800-531-5000. Please follow the installation instructions in the kit's user guide.

If you do not have Whole-Home DVR service:

### WIRED

#### Step 1 - Connect your DIRECTV HD Receiver to your router

Connect one end of your Ethernet cable to the Ethernet port on the back of your router.

Connect the other end of the Ethernet cable to the Ethernet port on the back of your DIRECTV HD Receiver.

#### Direct Connection

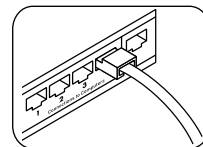
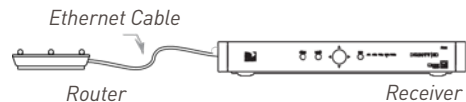

*Ethernet cable connects to an unused port on the router*

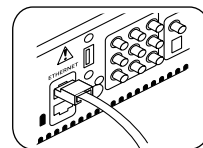

*Ethernet cable plugs into receiver*

## APPENDIX 4: HOW TO NETWORK YOUR HD RECEIVER

### Step 2 - Verify that you are connected

To verify you are connected:

- Press **MENU** on your DIRECTV Remote
- Select **Settings & Help**
- Select **Settings**
- Select **Network Setup**
- Choose **Connect Now** (or Test Connection if you have connected previously)
- Select **Continue** after successfully connecting to DIRECTV via the Internet (See figure A).

Select **Done** to complete the setup process (See figure B).

If your DIRECTV HD Receiver does not immediately recognize the network connection, you will get the option to choose the connection method. Choose **Wired** (See Figure C). Follow the onscreen instructions.

Figure A

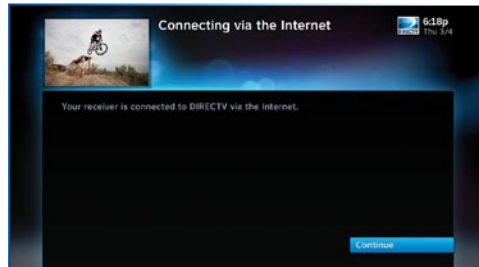

Figure B

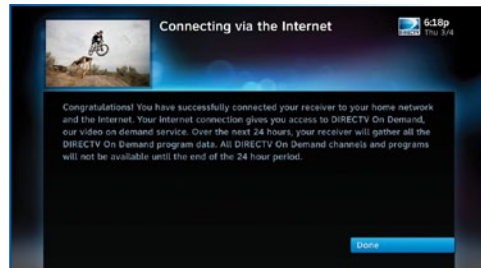

Figure C



## WIRELESS

Create a wireless connection between your wireless router and your DIRECTV HD Receiver, so your receiver can access the Internet.

Along with the Network Requirements at the beginning of Appendix 2 you will need:

- A wireless adapter that uses an Ethernet port to connect to a media device, preferably the DIRECTV CINEMA Connection Kit - Wireless, as mentioned above. [USB devices are not supported by the DIRECTV HD Receiver]
- A wireless router (in place of a regular router). You must have initialized your wireless device for your home network before beginning to network your DIRECTV HD Receiver.

### Step 1: Connect your DIRECTV HD Receiver to the wireless adapter

Connect one end of the Ethernet cable to the Ethernet port on the back of the wireless adapter. Connect the other end of the Ethernet cable to the Ethernet port on the back of your DIRECTV HD Receiver. If using the DIRECTV Cinema Connection Kit - Wireless, follow connection instructions found in the user's manual that came with the device (or go to [directv.com/getconnected](http://directv.com/getconnected)) to determine proper connection.

Plug your wireless adapter into an electrical outlet.

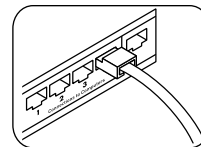
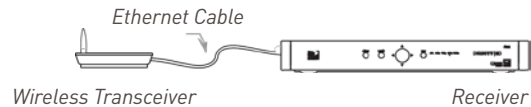

*Ethernet cable connects to the Ethernet port of the wireless adapter.*

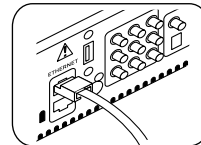

*Ethernet cable plugs into Receiver*

## APPENDIX 4: HOW TO NETWORK YOUR HD RECEIVER

Step 2 - Ensure the wireless adapter is recognized by your home network.

- Once your router detects the wireless adapter it will prompt you to configure the two devices.
- Select Set Up Now.
- Highlight your wireless network and press SELECT to display a blue dot next to your network. Then select Continue.
- Follow the onscreen instructions to complete the set-up process of the wireless adapter.

**NOTE:** If you are having difficulty connecting to the Internet or need more information, visit [www.directv.com/getconnected](http://www.directv.com/getconnected).

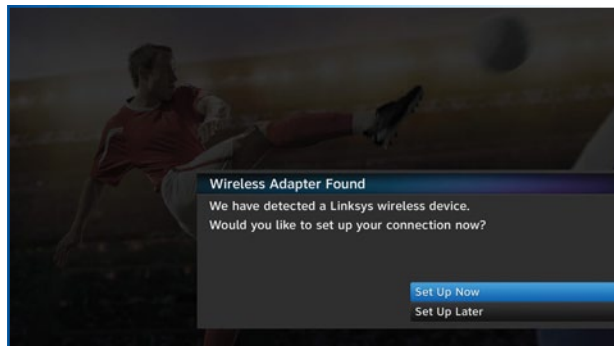



## APPENDIX 4: HOW TO NETWORK YOUR HD RECEIVER

### Step 3 - Verify that you are connected

To verify you are connected:

- Press **MENU** on your DIRECTV Remote
- Select **Settings & Help**
- Select **Settings**
- Select **Network Setup**
- Choose **Connect Now** (or Test Connection if you have connected previously)
- Select **Continue** after successfully connecting to DIRECTV via the Internet (See figure A).

Select **Done** to complete the setup process (See figure B).

If your DIRECTV HD Receiver does not immediately recognize the network connection, you will get the option to choose the connection method. Choose **Wireless** (See Figure C). Follow the onscreen instructions.

Figure A

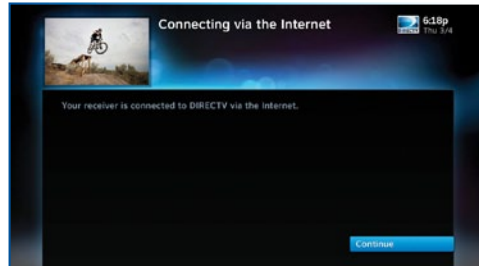

Figure B

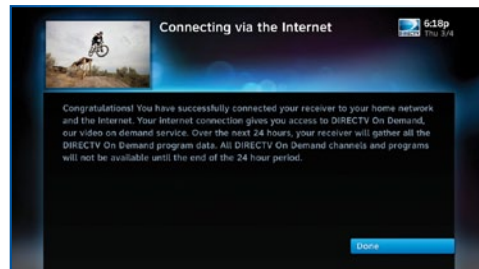
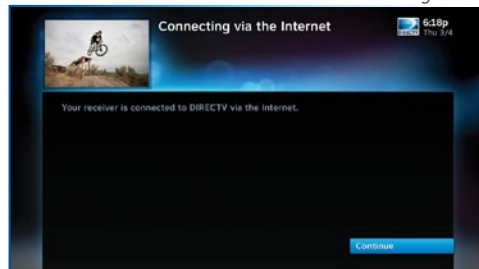

Figure C



# APPENDIX 5: ABOUT HIGH-DEFINITION

## SCREEN FORMAT & RESOLUTION

In addition to resolution and interlacing, a television picture is also defined by its aspect ratio—referring to the shape of the screen as defined by the ratio of the screen's width to its height. For analog TV, the aspect ratio is 4 units wide by 3 units high (4:3). This is the familiar shape of conventional TVs—slightly wider than they are tall. SDTV and EDTV pictures can be either 4:3 or 16:9. For HDTV broadcasts, the aspect ratio is 16:9—nearly twice as wide as it is tall. This is, not coincidentally, more like the shape of movies shown in theaters, which makes HD an ideal format for viewing movies on TV. You will be able to see much of what is captured on film, but lost on an SDTV display.

In order to optimize the display of programs on your television, you may occasionally need to change the resolution and/or screen format. There are two keys that can be used to make changes: the FORMAT key on the remote control and the RES (Resolution) key on the front panel of the DIRECTV HD Receiver. To change your Screen Format, TV Ratio, or TV Resolution settings, press MENU, select "Settings & Help", then "Settings", then "HDTV".

### FORMAT Key on Remote Control

Press the FORMAT key on your remote control to cycle through the resolutions supported by your TV, as well as, the screen formats in conjunction with each individual resolution. Available screen formats such as crop, stretch or letter/pillar box, are based on the TV Ratio setting. With each press, an onscreen message will let you know what the current resolution/format setting is.

For example, if you indicated that your TV supports only 1080i, 480i and 480p and it is a 16:9 television, and Native is turned off\*, the cycle of settings for the FORMAT key are as follows:

1st press: 480i/Stretch

6th press: 480p/Crop

11th press: 1080p/Letter box

2nd press: 480i/Letter box

7th press: 1080i/Stretch

12th press: 1080p/Crop

3rd press: 480i/Crop

8th press: 1080i/Letter box

13th press: Repeat Cycle

4th press: 480p/Stretch

9th press: 1080i/Crop

5th press: 480p/Letter box

10th press: 1080p/Stretch

**\*NOTE:** In Native mode, the receiver automatically adjusts resolutions to match the resolution of individual TV programs as they are tuned.

If Native is turned on, the FORMAT key cycles through Stretch, Letter and Crop for the current TV program's native resolution. The FORMAT key allows you to easily cycle all resolution and format settings with a single key until the picture displays the way you like it. If pressing this key causes a loss of video and audio, continue to press it until the picture returns. (Wait a second between presses to allow the Receiver to change the resolution.) This can happen if your settings include a resolution that your TV doesn't support. To correct this, you'll need to change your resolution setting: Press MENU, select "Settings & Help," "Settings," "HDTV" and then select "TV Resolutions." Mark or unmark the TV Resolutions to display the resolutions supported by your television.

### Resolution (RES) Key on Receiver Front Panel

This key is used to through cycle all available resolutions on your DIRECTV HD DVR. It does not cycle through format settings. If video and audio are not appearing, it may be because the current resolution setting is not supported by your television. By pressing this key, you can check all available resolutions to see if that solves the problem. The lights next to the RES key on the front panel will light below the resolution to which the receiver is set; they will change with each key press.

## SUPPORTED RESOLUTIONS

The following table shows the resolutions that can be output from each type of connection:

Output Connection	Available Resolutions
HDMI	1080i, 1080p, 720p, 480i, 480p
Component Video (YPbPr)	1080i, 720p, 480i, 480p
S-Video	480i
Video (RCA Type/Yellow)	480i

**NOTE:** 720p, 1080i and 1080p are HD formats. 480i and 480p are not. S-Video and RCA outputs display all resolutions as 480i.

## APPENDIX 5: ABOUT HIGH-DEFINITION

### WIDE-SCREEN VS. STANDARD FORMATS

#### 4:3 TVs Showing 16:9 program

For a standard 4:3 TV showing a wide screen program, the program is too wide to fit on the screen. To alleviate this, choose:

**Letterbox:** With this format, the 16:9 image is shrunk until the entire width of the program fits on your TV. Since the aspect ratio of the program is maintained, the image is no longer tall enough to fill your screen, so gray or black bars are seen at the top and bottom of the screen. To change the bar color, press MENU, select "Settings & Help," "Settings," "HDTV" and then "Video." Select the desired bar color. See your TV's owner's manual for information on the best color for your set.

**Stretch:** In the Stretch setting, instead of adding bars to the top and bottom, the 16:9 program image is stretched vertically until it's tall enough to fill the screen. Your entire screen will be full, but the program images are stretched to compensate.

**Crop:** This format crops (cuts off) the left and right portions of the 16:9 frame so it fits the 4:3 screen.

If your display is a 4:3 format TV or monitor, your format options include these:

For 16:9 program signals:



Letterbox



Stretch



Crop

## 16:9 TVs Showing 4:3 programs

For a wide screen 16:9 TV showing a standard 4:3 TV program, the program is too tall to fit the screen. Your choices here include:

**Pillar Box:** Here the 4:3 image is shrunk until the entire height of the program fits on your TV. Since the aspect ratio is maintained, the image is no longer wide enough to fill the screen, so gray or black bars are seen at the left and right edges. To change the bar color, press MENU, select "Settings & Help," "Settings," "HDTV" and then "Video." Select the desired bar color option. See your TV's owner's manual for information on the best color for your set.

**Stretch:** In this setting, instead of adding bars to the sides, the 4:3 program image is stretched horizontally until it's wide enough to fill the screen. Your entire screen will be full, but the images are a little stretched to compensate.

**Crop:** This format crops (cuts off) the top and bottom of a 4:3 frame, keeping the 4:3 ratio intact.

If your display is a 16:9 format TV or monitor, your format options include these:

For 4:3 program signals:



Pillar Box



Stretch



Crop

# INDEX

## A

- Access Card - 7, 8, 40, 46, 58, 88, 96
- Activation - 88
- Adult Channels - 50
- Audio Connections - 91-94
- Audio - 43, 65, 91
- Audio/Video Options - 22
- Audio sync - 65
- Advance - Back Cover
- Autotune - 23, 26-28, inside back cover
- Auxiliary Equipment - 90-94

## B

- Back Panel - 97-98
- Batteries - 10

## C

- Caller ID - 24, 29, 66, 98
- Captioning - 43
- Category Sort - 19
- Closed Captioning - 21, 41
- Channel Banner - 20-22, 41, 43, 96
- Channel Blocks - 50
- Clock - 40, 43
- Component Video Output - 90, 91, 92, 93, 98
- Connections - 58, 89-94
- Customer Care - 53, 76

Customize Guide see Favorite Channel Lists

## D

- 3D Channels - 15
- Date & Time - 19
- Defaults - 46-47
- Deleting - 36
- Destination Buttons - 11
- Digital Audio - 43, 90-94, 98
- DIRECTV Active Channel - 24, 28, 96
- DIRECTV CINEMA™ - 16, 99, 100, 101, 103
- DIRECTV Menu - 23-24
- DIRECTV Mode - 10, 62, 67, 88
- DIRECTV PROTECTION PLAN - 73
- DIRECTV® Whole-Home DVR Service - 24, 34-38, 45, 89, 99, 100, 101
- Display - 22, 40-43
- Dolby® Digital - 42
- DVD player/burner - 90, 91, 98

## E

- Episodes - 14, 37, inside back cover
- Error Messages - 56, 57
- Ethernet - 34, 98, 99-103
- Exit - 11, back cover
- Extras - 23, 24, 26-31

## F

- FAQs - 59-68
- Favorite Channel Lists - 19
- Favorite Channels - 21, 52
- FCC Customer Information - 74-76
- Filtering the Guide - 18
- Front Panel - 56, 95-96

## G

- GameSearch™ - 32
- GSN Game Lounge - 24, 29
- Guide - 23-24
  - banners - 41
  - channel types - 14-15, 17
  - customizing - 18
  - favorite channels - 21, 52
  - filtering - 18
  - jump to a date and time - 19
  - options - 19
  - sorting programs - 19
- Guided Setup - 88

## H

- HD
  - about - Appendix 5
  - channels - 15, 40
- HD & SD Channels - 15
- HDMI - 90-94, 98, 108
- HDTV - 15, Appendix 5
- Help - 24, 53
- History - 27

## I

Icons - 14, 20, 26, 27, 33, 43, 116, inside back cover  
 Info & Test - 40  
 Installation - 71, 74, 76, 99, 101  
 Interactive Channels - 17, 28, 89  
 IR/RF Setup - 44, 45

## K

Keyword Search - 23, 27

## L

Language - 22, 41, 43, 47, 49, 88  
 Last 4 - 21  
 Local Channels - 14  
 Lock (Parental Controls) - 22, 47

## M

Main Menu - 11, 23-24, 96  
 Manage Autotunes - 26-28  
 Manual Autotune - 28  
 Messages - 20, 24, 26, 57, 63, 67, 88, 96, 106, back cover  
 Mini Guide - 18, 26  
 MODE Switch - 10, 44, 58, 62, 67, 88, back cover  
 Model Number - 8, 45, 74, 96  
 Movie Ratings - 49  
 Mute - 65, 66, back cover

## N

Navigation Buttons - 11  
 Network - 30, 34, 38, 44, 45, Appendix 4  
 News Mix Channels - 17

## O

Other Shows Ratings - 49  
 Onscreen messages - 57

## P

Parental Controls - 22, 48-52  
     adult channels - 50  
     channel blocks - 50  
     hours (viewing) - 51  
     locking - 22, 47  
     passcode - 48  
     ratings - 48-49  
     spending - 51  
     unlocking - 48  
 Passcode - 48  
 Pay Per View - 16, 19, 27, 51, 89, 98  
 Phone Connection - 58, 89  
 Playlist - 35, 36, 38, 100  
 Power - 7, 10, 56, 60, 61, 62, 74, 76, 90, 96, 98, back cover  
 Power Saving - 46  
 Power Surge - 7, 62, 73  
 Press and Hold Buttons - back cover  
 Previous Channels - 21, back cover

Product Information - 8  
 Program Guide (see Guide)  
 Program Info - 14  
 Progress Bar - 30, 59  
 Purchases - 16, 27, 51, 57, 89

## Q

QuickTune - 32

## R

Ratings - 48-49  
 RCA connectors - 93, 98  
 Rear Panel - 97-98  
 Reauthorize Receiver - 56  
 Receiver Problems - 59, 61, 62  
 Recent Searches - 23  
 Remote Control - 10-11, 44, back cover  
     buttons - 10-11, back cover  
     modes - 10  
     problems - 67  
 Repair - 70-72, 76  
 Reset - 46  
     passcode - 47  
     receiver - 46, 56  
 Resolution - 22, 40-42, 60, 61, 67, 68, 96, Appendix 5  
 Resolution Indicator - 96  
 Restart - 46  
 RF Remote - 44, 45, 96, 98

# INDEX

Rotten Tomatoes™ - 14  
Router - 99-104

## S

Satellite Data Acquisition - 59  
Satellite Signal Strength - 45  
Self-Installed DIRECTV Connection Kit-  
Wireless - 101  
ScoreGuide™ - 33  
Scrolling Effects - 41  
Searching for programs - 23  
Settings & Help - 24, 40-53  
Setup [see Setting & Help]  
Shortcut Buttons - 11  
Shortcut Hints - 11, 14  
Software - 17, 26, 40, 57, 77-86  
Software License - 77-86  
Sort - 19  
Sound Effects - 43  
Spending Limits - 51  
Sports Mix Channels - 17  
Subtitling - 21  
Surround Sound - 43  
System Info - 40  
System Messages - 20, 26, 46, 57  
System Settings - 40-47  
System Setup - 40-47  
System Software Updates - 57  
System Test - 58

S-Video - 68, 90, 92, 107

## T

Temporarily Unlock - 48  
The DIRECTV Menu - 23-24  
To Do List - 11, 27, 38, 59, back cover  
Troubleshooting - 56-58  
TV Apps - 33  
TV Input Button - 60  
TV Options - 20-22  
TV Problems - 60, 65  
TV Ratings - 49  
TV Ratio - 42, 106

## U

Unlock Now (Parental Controls) - 48  
Unsubscribed Channels - 15

## V

VCR - 90-94, 98  
Video - 22, 30, 31, 32, 40, 41, 53, 56, 60,  
65, 90, 91-94, 98, 107, 109  
Viewing Hours - 51

## W

Warranty - 70-72  
Whole-Home DVR Service - 24, 34-38,  
45, 89, 99, 100, 101  
Wired - 101-102  
Wireless - 103-105















ACTIVATION OF PROGRAMMING SUBJECT TO CREDIT APPROVAL. CREDIT CARD REQUIRED (except in MA and PA). Programming subject to change. DIRECTV services not available outside the U.S. DIRECTV Programming is available separately and independently of DIRECTV System hardware. A valid programming subscription is required to operate DIRECTV System hardware. Activate your DIRECTV Programming today at 1-800-DIRECTV (1-800-347-3288). © 2011 DIRECTV. DIRECTV and the Cyclone Design logo, DIRECTV Active, DIRECTV INTERACTIVE and DIRECTV CINEMA are trademarks of DIRECTV, Inc. All other trademarks and service marks are the property of their respective owners.

This item incorporates copy protection technology that is protected by U.S. patents and other intellectual property rights of Rovi Corporation. Reverse engineering and disassembly are prohibited.

Due to restrictions imposed by copyright holders, certain programming may include content protection measures that may restrict viewing in high-definition and/or recording with certain consumer electronics equipment attached to the receiver. Please contact the manufacturer of such equipment for additional information.

THIS PRODUCT IS LICENSED UNDER THE AVC PATENT PORTFOLIO LICENSE FOR THE PERSONAL USE OF A CONSUMER OR OTHER USES IN WHICH IT DOES NOT RECEIVE REMUNERATION TO (i) ENCODE VIDEO IN COMPLIANCE WITH THE AVC STANDARD (“AVC VIDEO”) AND/OR (ii) DECODE AVC VIDEO THAT WAS ENCODED BY A CONSUMER ENGAGED IN A PERSONAL ACTIVITY AND/OR WAS OBTAINED FROM A VIDEO PROVIDER LICENSED TO PROVIDE AVC VIDEO. NO LICENSE IS GRANTED OR SHALL BE IMPLIED FOR ANY OTHER USE. ADDITIONAL INFORMATION MAY BE OBTAINED FROM MPEG LA, L.L.C. SEE [HTTP://WWW.MPEGLA.COM](http://www.mpegla.com).

# ICON REFERENCE

<b>Arrow Icons</b>		Indicate that a show's start or end time is earlier or later than is visible in the Guide program cell.
		LEFT arrow on the remote offers special functionality.
		Objects are scrollable above or below the visible window
		UP and DOWN arrows on the receiver front panel offer special functionality.
<b>Other Icons</b>		Indicates a program is set to Autotune
		Indicates Autotune has been set for all episodes of an ongoing program.
		Indicates showing that was set by the user was canceled by the scheduler due to an unexpected conflict.
		Shows Autotune has been set for matching programs in a Search.
		Indicates one or more new messages are in the Inbox.
		Shows that Parental Control limits are currently "locked."
		Shows that Parental Control limits are temporarily unlocked.
	Shows that there are no current limits imposed.	

## Other Icons



Indicates a rating level or channel that is blocked via Parental Controls.

**24**

“All Day Ticket” indicates that the program is rented for 24 hours starting when you first view the program.

**LB**

Indicates program shown in letterbox format.



Denotes an error condition has occurred.



Appears when at least one rating or channel is allowed.



Appears when at least one rating or channel is blocked.



Used to create/enter passcodes in parental controls.



Onscreen color hint indicating a special function activated by pressing the related color button on the remote control.



Indicates a fee applies for viewing program.

**HD**

Indicates the program is/will be broadcast in High-Definition format.

## MODE SWITCH

Changes remote to control other equipment, for example a DVD Player.

## TV INPUT

Changes the "source" - the piece of equipment whose signal is displayed on your TV.

## FORMAT

Cycles through screen formats (crop, stretch, pillar box, letter box) and resolutions.

## STOP

Stops Recorded Video

## REPLAY

Jumps back 6 seconds. Hold down to jump back to the beginning.

## REWIND

Press up to four times to rewind at increasing speed.

## PAUSE

Pauses current video.

## ACTIVE

Displays the DIRECTV Active Channel - local weather and more!

## GUIDE

Press once to see the Program Guide. Press twice to see programs by category.

## SELECT

Selects any highlighted item.

## BACK

Takes you back one menu screen.

## MENU

Display a menu of settings and services.

## RED

In Guide, jumps 12 hours back; other functions vary - look for hint on screen.

## GREEN

In Guide, jumps 12 hours forward; function varies on other screens - look for onscreen hints.

## VOLUME

Raises or lowers volume.

## MUTE

Toggles sound volume on/off.

## NUMBERS & DASH

Tune to a channel directly; also input numbers when needed in on-screen menus.



## DIRECTV & TV POWER ON

Turns your DIRECTV® Receiver and TV, together, on or off.

## POWER

Turns on/off whichever equipment the MODE switch is set to.

## ADVANCE

Jumps ahead 30 seconds. Hold down to jump forward to the end.

## PLAY

Play current video; press and hold for slow motion.

## FFWD

Press up to four times to fast forward at increasing speeds.

## RECORD

Press once to record a live TV program or the program highlighted in the Program Guide. Press twice to record a series.

## LIST

Displays the Playlist.

## EXIT

Exits any menu and returns to last channel viewed.

## ARROWS

Moves the highlight (up, down, left, right) within a menu.

## INFO

Displays information about the program you are watching or that is highlighted in the Program Guide.

## BLUE

In live TV, displays the Mini Guide; function varies on other screens - look for onscreen hints.

## YELLOW

Displays various options while viewing the Guide or the Playlist.

## CHAN/PAGE

In live TV, changes channel up or down; in a menu, such as the guide, scrolls page up and down.

## PREV

Times to previous channel viewed.

## ENTER

Activates channel number entries quickly.

Keys in **orange** text can be programmed to function with your VCR, DVD player or other stand alone equipment.

\* These descriptions apply to DIRECTV Digital Video Recorders. Other equipment may behave differently.



V1.2H21PLUST19JAN12